

---

# IMPLEMENTING BICYCLE IMPROVEMENTS AT THE LOCAL LEVEL

PUBLICATION NO. FHWA-98-105

1998



U.S. Department  
of Transportation  
Federal Highway  
Administration

PDF version created by the  
Bicycle Federation of America  
(c) 1999.



---

# INTRODUCTION

**W**ith the passage of the Intermodal Surface Transportation Efficiency Act of 1991 (ISTEA), metropolitan planning organizations throughout the United States were explicitly required to consider bicyclists in their long-range transportation plans. As a result, many post-ISTEA plans do include ambitious bicycling components intended to increase the levels and safety of bicycle use within the affected communities. In light of these events, the purpose of this document is to provide detailed information on how to implement some of the most useful and popular elements. As a result, the advice contained herein will be most useful for those at the local—typically below the Metropolitan Planning Organization (MPO)—level working to implement the MPO long-range plans.

The goal of bicycle planning at the local level is to provide for bicycle travel within the community. The purpose of doing so is to encourage more bicycling and to reduce the number of serious bicycling crashes and injuries. Building bicycle facilities is a key part of the encouragement side of this effort. But such efforts typically mean focusing on small-scale improvements and local environments. Since the typical bicycle trip is less

*The goal of bicycle planning at the local level is to provide for bicycle travel within the community. The purpose of doing so is to encourage more bicycling.*



than two miles in length, regional plans tend to overlook issues of most concern to bicyclists. . .the drain grate that can catch a wheel, the lack of a bike lane on a main street, and the barrier between a neighborhood and nearby park.

Clearly, much of the most important bicycle-related work in a community will happen at the micro-level and will involve paying attention to “nuts and bolts” issues. To deal with these problems, however, often requires taking a step back. Instead of simply focusing, for example, on a particular unresponsive traffic signal, the best approach may well be to create a

program that routinely fixes such signals whenever an intersection is modified or whenever a complaint is received. Such an approach should also include standards for new construction that specify bicycle-responsive loop detector designs. In this fashion, it is possible to have a community-wide effect that can truly improve conditions wherever bicyclists ride.

## PLANNING STRATEGY

It's important to start with a basic understanding of the current situation. While in some instances it may be possible to do a complete survey of local conditions, in many cases, a more basic approach will work just fine.

The suggestion here is to start with a checklist of possible problems or existing environmental or program features (as shown on pages vii-ix) and then proceed to implement improvements through the use of an interactive and responsive program. For the most part, such a program can be managed as part of an agency's routine function.

As an example, the checklist suggests replacing bicycle-unfriendly drainage grates. One basic step in such an effort is to find out what grate standard the street department currently uses. If it uses an unacceptable model, then there are several steps that follow in the effort to improve the safety of the roadways: (1) change the grate standard for new construction; (2) have the street department use the new standard whenever it replaces or modifies a current installation; and (3) budget a reasonable amount of money for annual grate replacement, based on public requests and a quick prioritization of street system (e.g., any popular bicycling streets and bike routes at the top and unpopular streets at the bottom).

## PROJECT PRIORITIES

The sections that follow the checklist describe some of the programs and projects found in America's most progressive "bicycle-friendly" communities. They range from trail networks and transit system connections to rubberized railroad crossings and bicycle parking. Some are modest projects while others are major undertakings.

While each project and program can be seen as part of a larger comprehensive planning effort, each can also be implemented singly. Implementation can be accomplished in phases that best reflect local realities. Since, for example, it would be easy to replace dangerous grates but more difficult to build a bridge across a major river, the former could be done almost immediately and the latter as funding and support materialize. Similarly, if the zoning ordinance is currently being revised, it might be best to start with adding bike parking requirements to the parking chapter. It is both possible and desirable to pick and choose those projects and programs from the list that have local appeal and are doable.

Such an approach makes it possible to get things going almost immediately and to start making a real difference in the community, often at minimal expense. Of course, some projects are expensive. For instance, if there is a need for a grade separated freeway crossing, such a project can easily cost upwards of \$300,000 to \$500,000. Planning for such an expenditure can take several years and may involve grant applications or implementation through the Transportation Improvement Program process and the use of any one of several categories of Federal funds. However, in the

meantime, many small but important changes can be made as the community works its way toward bicycle friendliness.

Many local bicycle programs have found, for example, that small initial successes build momentum allowing more ambitious works to follow. In one southern community, for instance, striping bike lanes on two collector streets near the local university—a project that took several days of work and less than \$1000 to accomplish—helped build support for an important \$500,000 bicycle bridge.

The checklist below briefly describes projects that are more fully explored in the sections of this report that follow (each section is numbered in accordance with this list). While not every possible bicycle program or project is included in this checklist, it does include some of the most important.

## CHECKLIST OF CATEGORIES OF GENERAL IMPROVEMENTS

### 1. Major urban streets

**Typical concerns:** *High traffic volumes and speeds, lack of space for bicyclists.*

**Possible projects:** *Widen outside through lanes or add bike lanes by either redistributing space on the roadway by restriping or adding paved width.*

### 2. Minor urban street traffic

**Typical concerns:** *Higher than appropriate traffic volumes and speeds on residential streets.*

**Possible projects:** *Create a traffic calming program that responds to neighborhood requests by installing a variety of measures.*

### 3. Minor street/major street crossings

**Typical concerns:** *Bicyclists have difficulty crossing busy arterial thoroughfares from quiet residential streets .*

**Possible projects:** *Provide median refuges at key minor street crossings, bike-friendly signals, and other features on collectors.*

### 4. Breaking bicycling barriers

**Typical concerns:** *Physical features (rivers, creeks, railroads, freeways) often keep bicyclists from getting where they want to go.*

**Possible projects:** *Provide independent bicycle/pedestrian structures where necessary or combine bicycle/pedestrian structures with other existing or planned transportation facilities.*

### 5. Trail networks

**Typical concerns:** *Trails are popular facilities among the bicycling public but they may be rare or discontinuous. In addition, some are poorly designed, constructed, or maintained.*

**Possible projects:** *Provide new trails where possible throughout the community, connect existing trail segments, and encourage developers to include trails in their developments. Make sure designers and operations staff use current literature in their work.*

## 6. Transit connections

**Typical concerns:** *The success of a multimodal transportation system suffers when bicyclists cannot get to transit stations, when there is not adequate safe bicycle storage, and when bicyclists are not accommodated on the system itself.*

**Possible projects:** *Improve connections between residential areas and transit stops, provide secure bicycle parking at stops, and provide for carrying bicycles on the system.*

## 7. Roadway bridge modifications

**Typical concerns:** *Some bridges contain narrow outside lanes, hazardous deck surfaces, hazardous expansion joints, high traffic volumes, high traffic speeds, or high speed on- and off-ramps.*

**Possible projects:** *Reallocate bridge deck width by shifting lane lines, modify surface for better bicycle stability, modify ramps to discourage high-speed turning movements, and, as a last resort, develop bicycle connections independent of the bridge in question.*

## 8. Railroad crossings

**Typical concerns:** *Diagonal railroad crossings and rough crossings—regardless of crossing angle—can cause bicycle crashes.*

**Possible projects:** *Replace dangerous crossings with rubberized installations (especially in the outside through lane), use flangeway fillers on low-speed diagonal crossings, flair paved surface at crossing approaches to allow right-angle crossings, and use warning signs or markings.*

## 9. Traffic signals

**Typical concerns:** *Most traffic-actuated signals have difficulty detecting bicycles. In addition, signal timing may not allow sufficient clearance time for bicyclists to get through an intersection, and programmed visibility heads may not be as visible from a typical bicyclist's location as from a typical motorist's location.*

**Possible projects:** *Provide bicycle-sensitive loop detectors in new installations and retrofit where needed; in some cases, use pavement markings to identify most sensitive locations; adjust timing requirements on signals and test heads for visibility at necessary angles.*

## 10. Drainage grates and utility covers

**Typical concerns:** *Some drainage grate designs can trap a bicycle wheel; in addition, grates and utility covers should be kept level with the grade of the street surface and, wherever practical, such installations should be kept out of the typical path of a bicyclist.*

**Possible projects:** *Replace bad drain grate standards with bicycle-safe models; replace or modify existing installations; as a routine practice, consider bicyclists when locating new utilities.*

## 11. Rural road shoulders

**Typical concerns:** Many rural roads serve high-speed traffic and, in some cases, high volumes of motor traffic containing a significant proportion of large trucks. For bicyclists, sharing narrow roads with such traffic can be unpleasant and dangerous.

**Possible projects:** Provide smooth paved shoulders on all new construction and reconstruction; add shoulders to popular bicycling routes; adopt standards calling for adequate paved shoulders; restrict the use of rumble strips when bicycle traffic is expected, and on new construction and reconstruction; or provide space for future shoulders if they cannot be installed at the time.

## 12. Bicycle parking

**Typical concerns:** Scarce bike parking at popular destinations, undesirable bike parking devices, no bike parking zoning requirements.

**Possible projects:** Each year, provide new bike parking as a routine practice; use only parking devices that accept high security locks; or add bike parking to local zoning regulations.

## 13. Maintenance

**Typical concerns:** Poorly maintained trails and roadway edges.

**Possible projects:** Alter current practices, create a user-requested bicycle spot improvement program.

## REFERENCES

- Bicycle and Pedestrian Planning Under ISTEA*, FHWA, 1994  
*Guide for the Development of Bicycle Facilities*, AASHTO, 1998 (pending)  
*North Carolina Bicycle Facilities Planning and Design Guidelines*, NCDOT, 1994



# MAJOR URBAN STREETS

*In many communities, bicyclists feel squeezed out of the traffic mix. Providing bike lanes or wide curb lanes on major urban streets can enhance mobility and access for bicyclists.*



## PROBLEM OVERVIEW

In many communities, bicyclists feel squeezed out of the traffic mix. Studies under way at the Traffic Institute at Northwestern University and the University of North Carolina show that most bicyclists (i.e., casual adult riders and kids) feel high levels of stress while riding on busy streets. While in some cases it is possible for them to ride on quiet back streets, such streets suffer from some serious problems of their own: 1) quiet back streets may take bicyclists to no important destinations; 2) they may be discontinuous; 3) they may be badly paved; 4) they may have many sight obstructions and low-visibility intersections; and 5) it may be very hard to cross busy arterial roads.

Many major urban and suburban arterial and collector streets, on the other hand, have some distinct advantages: 1) they are protected from minor street cross traffic; 2) they have relatively few sight obstructions; 3) they serve most of the popular destinations; 4) they are continuous; and 5) they are probably in better shape than the back streets. However, they typically suffer from high levels of motor vehicle traffic, congestion caused by on-street parking, and relatively narrow outside lanes.



## SOLUTION OVERVIEW

While not applicable to all streets, it is often possible to create space for bicyclists by altering the roadway's channelization. On existing roadways, this may mean eliminating or reducing the width of other lanes. On new construction, it may mean adding space to the roadway and, possibly, acquiring additional right-of-way.

## OBJECTIVES

To provide adequate space for bicyclists on collector and arterial streets:

- By reallocating space to provide either bicycle lanes or widened curb lanes on existing streets.
- By designing new roads with either bicycle lanes or widened curb lanes as part of the typical cross section.

## IMPLEMENTATION STRATEGIES

Implementing changes to the major street network involves the identification of an overall network of connected bicycle improvements, combined with action on a project-by-project basis. Specific routes may be more difficult to implement than others for reasons of geometrics, politics, or traffic considerations.

One of the most important aspects of the implementation strategy is on-going and pro-active public involvement. Several key publics should be closely involved in the process: 1) bicyclists (including casual adult riders and children); and 2) property owners whose land may be impacted by changes in channelization (e.g., elimination of parking).

## SUBTASKS

### 1. Identify key corridors

With a map of the arterial and collector system, focus particular attention on those streets that combine important characteristics: 1) close proximity to residential areas; 2) serve potentially popular destinations (parks, shops, schools, work centers); 3) continuous with good access to surrounding neighborhoods; and 4) few nearby alternatives for through access.

### 2. Prioritize the corridors

Some potential streets will be higher priority than others. Highest priority streets would include: 1) those with high levels of existing bicycle use; 2) those with evidence of potential bicycle use (e.g., lots of nearby neighborhood riding); 3) streets that can be easily modified; and 4) those that connect residential areas with potentially popular, but otherwise unreachable destinations.

### 3. Determine likely alternatives

For basic guidance on which treatments to apply to particular streets, look at the options given in the report, *Selecting Roadway Designs for Accommodating Bicycles* (FHWA, 1994). However, in addition consider the following:

- For each street, also look at the available space and its overall level of complexity. In terms of space, striping bicycle lanes will require between 1.2 m and 1.5 m (4 ft and 5 ft) per direction, depending on conditions. For two directions, then, the required space will be between 2.4 m and 3.0 m (8 ft and 10 ft). The question, then, becomes: Is this amount of space available or can it be found? Several options for finding the space include: 1) eliminating a parking lane; 2) narrowing through lanes or turn lanes; and 3) eliminating through lanes or turn lanes. Eliminating a parking lane may help achieve other traffic-related goals but may be politically difficult in some cases. Narrowing lanes should be done with careful attention to capacity and safety concerns. Level of service should be carefully considered when eliminating lanes.
- The wide curb lane option requires making the outside through lane between 4.2 m and 4.5 m (14 ft and 15 ft) wide. This may be accomplished by narrowing other travel lanes or eliminating a parking lane.
- Very complex streets—those with multiple sets of high-speed ramps connecting with interstate highways and multiple turn lanes in either direction—tend to be difficult situations in which to install designated bicycle lanes. They may be best served by wide curb lanes or, if speeds are high, striped shoulders. On the other hand, standard arterial or collector streets with normal four-legged intersections can be relatively easy to stripe for bicycle lanes.
- Finally, consider public support. If there is community interest in serving utilitarian bicycling needs, then the trade-offs required for bicycle lane installation will be more easily negotiated. Most casual adult riders see little improvement when a wide curb lane is installed but many appreciate the designated space provided by bicycle lanes. Most observers agree that designated lanes are most likely to encourage greater utilitarian bicycling.

#### 4. Assemble a network

Look at the list of potential streets as a system or network of on-street bicycle facilities. In this light, determine where the proposed network breaks down, has gaps, or misses important destinations. Such areas may need to be served by other options, like: 1) barrier-breaking bridges or underpasses; 2) short sections of trail; or 3) bicycle routes or traffic-calmed “bicycle boulevards” through particular neighborhoods.

#### 5. Phase the development

With the complete network planned, it is next important to develop a phasing proposal for the development. The first phase may include a combination of: 1) critically important segments; 2) segments that can be included as incidental features of other planned projects; 3) segments that may disappear in the future if they are not implemented soon; and 4) segments that can be easily accomplished. These last segments can be very important since they can help establish a track record.

Subsequent phases may include less critical connections, projects that may “ride along” on future transportation projects, and expansions based on new development.

## 6. Implement the system

Implementing a system of bicycle improvements on major urban streets, according to the phasing scheme, requires engineering design work, combined with the cooperation of street department personnel and continued public involvement to ensure acceptance. The diagram below shows options for modifying a four-lane urban roadway with on-street parking.

Further, while striping bike lanes or wide curb lanes may seem like a simple change, it may take more effort and time than at first imagined. For instance, existing striping patterns may be difficult to remove or modify, especially if thermoplastic markings have been inset into specially ground depressions in the paved surface. Even paint stripes can be difficult to remove, and stripes that have been removed may still be visible and, as a result, confusing to travelers under certain conditions (e.g., on rainy nights).

Figure 1.1  
Three options for modifying a typical 64-ft-wide four-lane roadway to improve the situation for bicyclists

Source: Lubbock Metropolitan Area Comprehensive Plan, Bicycle Federation of America

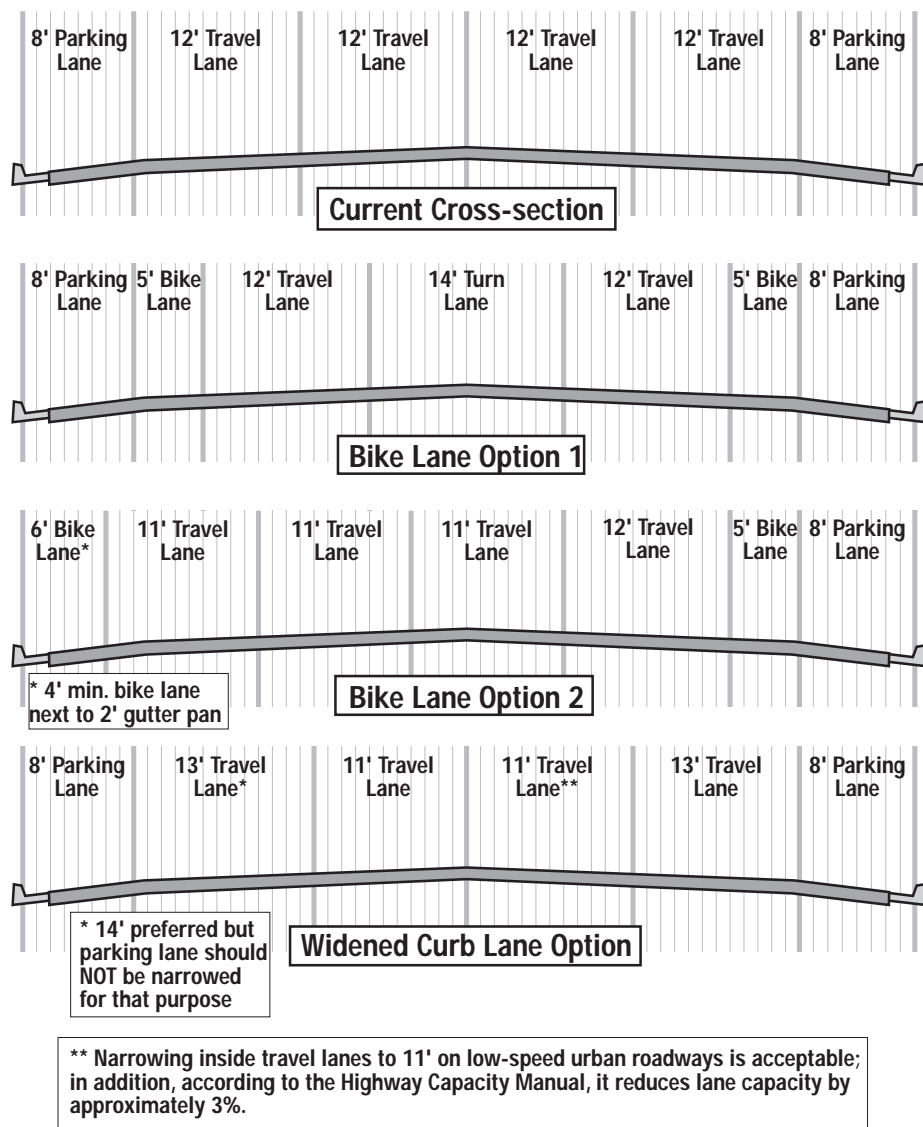

In general, the easiest and best way to stripe either bicycle lanes or wide curb lanes is when a new pavement overlay has been added and utilities and grates have been adjusted.

Such an opportunity should not be missed. At the same time, designers should be careful not to stripe sections of bicycle lane that end at difficult locations and force bicyclists to share narrow traffic lanes with high speed traffic. Each phase of such a project should be safe in and of itself.

## 7. Evaluate the results

Keep track of the results of the program as each phase is implemented. Study bicycle traffic volumes before installation and after; in subsequent years, it is helpful to do additional bicycle counts to determine changes in use. Cities like Madison, Wisconsin, have counted bicycles in key corridors for many years and have used the results to improve their system. It's also useful to look at certain bicyclist behaviors before and after implementation. For example, bicycle use of the sidewalk may change when bicycle lanes are installed.

*Bike lanes are for the preferential or exclusive use of bicyclists. They should be designated by lane striping, regulatory signs, and pavement markings.*



## RESOURCE REQUIREMENTS

In general, the physical resources (e.g., paint, signs) required for striping either bicycle lanes or wide curb lanes are not as significant as the labor required to plan, design, and implement the system. As a result, implementing some of the “easy” segments may be done with relatively little extra expense and can often be handled within an agency’s current fiscal year using contingency funding sources.

## SCHEDULE

**Short-term:** Short-term projects include critically important connections, easy restriping projects, projects that can be treated as incidental aspects of current transportation projects, or projects that can take advantage of new pavement overlays.

**Long-term:** Long-term projects include more complex restriping projects, projects that are likely to engender greater public concern (e.g., loss of on-street parking), and projects that will be completed as incidental parts of major transportation improvements.

## SPECIFICATIONS

### Bicycle lanes

Bicycle lanes should conform to the AASHTO *Guide for the Development of Bicycle Facilities* (1998—pending) or local standards, if applicable. The following are basic points that should be followed. Circumstances may require deviating from these requirements in some special cases; however, such cases should be carefully considered and mitigating measures applied.

**1. Width:** Bicycle lanes should be at least 1.5 m (5 ft) wide, from the lane stripe to the curb face (see #1 below). In addition, there should be at least 1.2 m (4 ft) between the bicycle lane stripe and the joint between the pavement and the gutter pan. When next to parking, bicycle lanes should be at least 1.5 m (5 ft) wide (see #2). When no curb and gutter section is present, a 1.2-m (4-ft) bicycle lane will suffice and it should meet a smoothly graded shoulder at least 0.6 m (2 ft) wide.

Figure 1.2  
Bicycle lanes provided  
under different types of  
conditions

Source: Lubbock Metropolitan Area  
Comprehensive Plan,  
Bicycle Federation of America

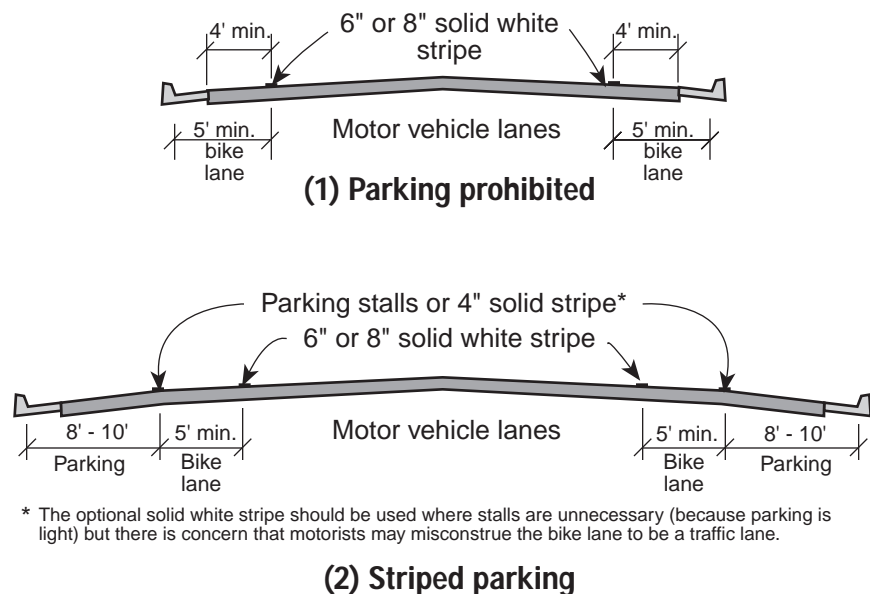

**2. One-way:** On two-way streets, one-way bicycle lanes must be provided on each side, to the right of the right-most through lane. Under no conditions should two-way bicycle lanes be provided on one side of the street.

**3. Side of road:** On one-way streets, a one-way bicycle lane should generally be provided on the right side of the road. Special circumstances may dictate striping a particular bicycle lane on the left side. Such circum-

stances could include greater numbers of potential conflicts—like busy bus routes, double right turn lanes, or high-turnover parking—that exist on the right side. The conditions should be carefully documented.

**4. Designation:** Bicycle lanes should be designated by lane striping, regulatory signs, and pavement markings. The diagram below shows an approach based on the recommendations in the Manual on Uniform Traffic Control Devices (FHWA, 1988). Some agencies with a great deal of experience have found that the MUTCD’s approach can result in too many signs.

Some, for example, only use the bicycle warning signs on cross streets where a likely conflict may arise. Other agencies use a word message (“Bike

Figure 1.3  
Possible designation for bicycle lanes  
Source: Lubbock Metropolitan Area Comprehensive Plan, Bicycle Federation of America

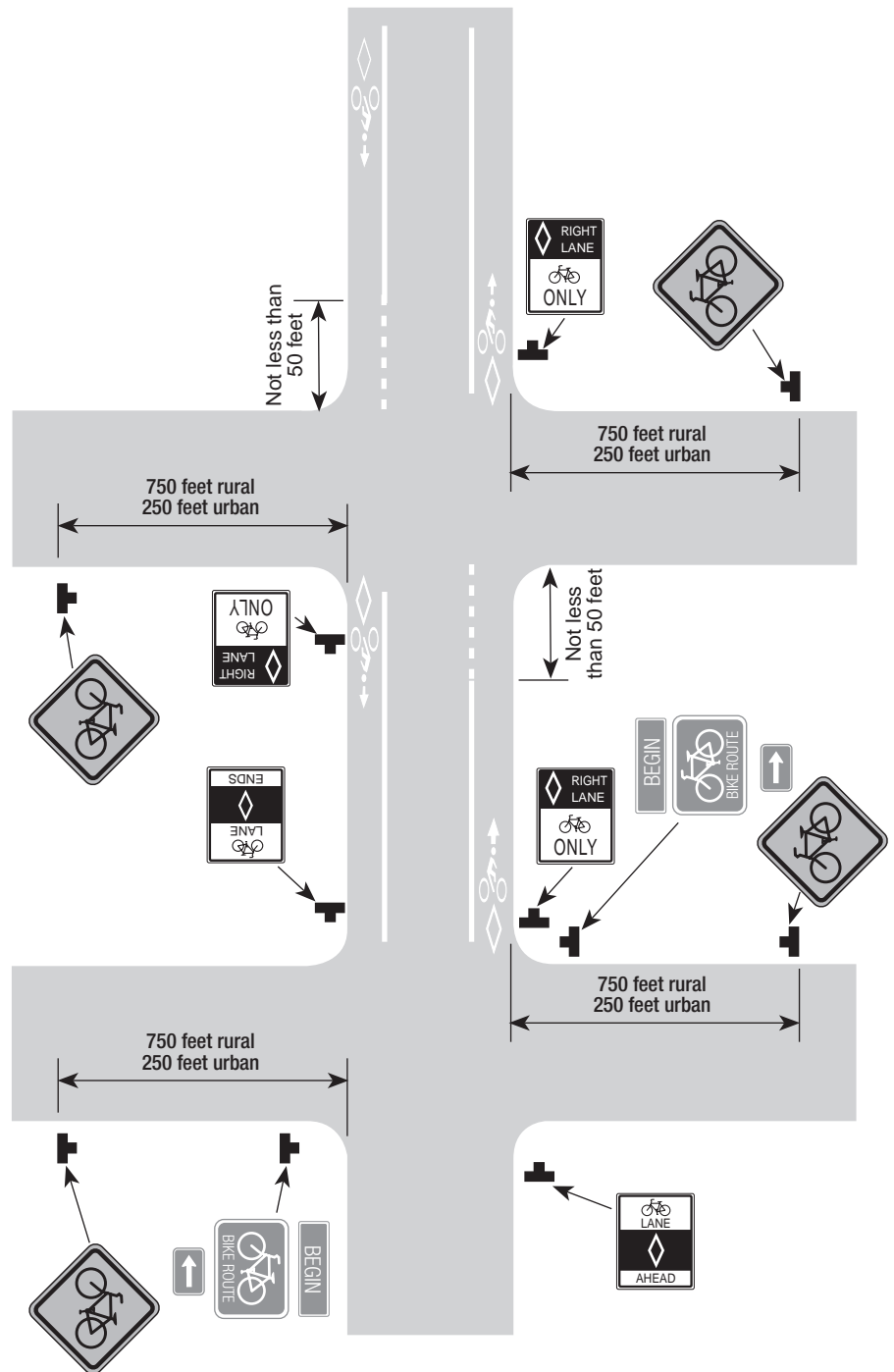

Lane”) instead of the diamond symbol. Their “Bicycle Only” signs would be simplified to eliminate the diamond as well. Before deciding on an approach for local bike lane striping, signing, and marking, find out what the State agencies and other, more experienced local jurisdictions are using in your area. In addition refer to the MUTCD.

**5. Striping:** Bicycle lanes should be separated from other travel lanes by a 15-cm or 20-cm (6-in or 8-in) solid white stripe. In general, a bicycle lane stripe may be solid from the beginning of a block to within 15 m (50 ft) of the end; at that point, it should be dashed until it hits the intersection (MUTCD, 1988). There should be no curb between bicycle lanes and the rest of the roadway, nor should bicycle lanes be placed on a sidewalk.

**6. Regulatory signs:** Bike lane regulatory signs should be used after significant intersections. In addition, the Oregon Bicycle Plan (ODOT, 1992) suggests posting signs at intervals equal to the speed limit multiplied by 40. Thus, on a 56 km/h (35 mi/h) street, signs would be placed approximately every 427 m (1400 ft). In addition, on-street parking between the curb and the bike lane can hamper the visibility of bike lane signing. In such cases, the Oregon Bicycle Plan suggests using pavement markings only.

**7. Pavement markings:** Bike lane pavement markings should be placed adjacent to bike lane regulatory signs (installed as described above). If regulatory signs are not used, more frequent pavement markings (e.g., after intermediate intersections or at midblock on very long blocks) should be used. They are also appropriate in the short sections of bike lane found to the left of right turn lanes.

**8. Intersections:** For the most part, intersections of streets that include bicycle lanes are relatively easy to handle. Simply dashing the bike lane stripe at the intersection approach and then picking up the solid stripe after the intersection is all that is needed. However, more complicated intersections require more attention.

At intersections with right-turn-only lanes, bicycle lanes should not be striped to the right of such lanes. In these situations, the need for the right-

*Where right turn lanes are provided at intersections, bike lane stripes should be dashed as they approach the intersection to indicate a merging of bicycles and right turning vehicles.*



turn-only lane should be evaluated based on turning volume warrants. If the right-turn-only lane is not necessary, eliminating it will make bicycle lane striping less complex. If it is necessary, the bicycle lane should be moved to the left (as shown below on the approach to an interstate highway on-ramp) or dropped, depending on how much space is available. One factor that often makes an intersection more difficult is the presence of a high-speed ramp with a wide radius. This tends to increase motor vehicle speeds and it makes merging and crossing maneuvers more difficult for bicyclists. Using a smaller turning radius for ramps and dedicated right turn slip lanes can lower motor vehicle speeds and improve conditions for both bicyclists and pedestrians.

The diagram below shows a range of four typical situations and some possible solutions. If possible, the preferable solution is to continue the bike lane to the left of the right turn lane rather than simply dropping it and forcing bicyclists to fend for themselves. Some designers feel that providing the short section of bike lane to the left of a right turn lane is almost more

Figure 1.4  
Bicycle lanes and right turn lanes: four options

Source: North Carolina Bicycle Facilities Planning and Design Guidelines; 1994

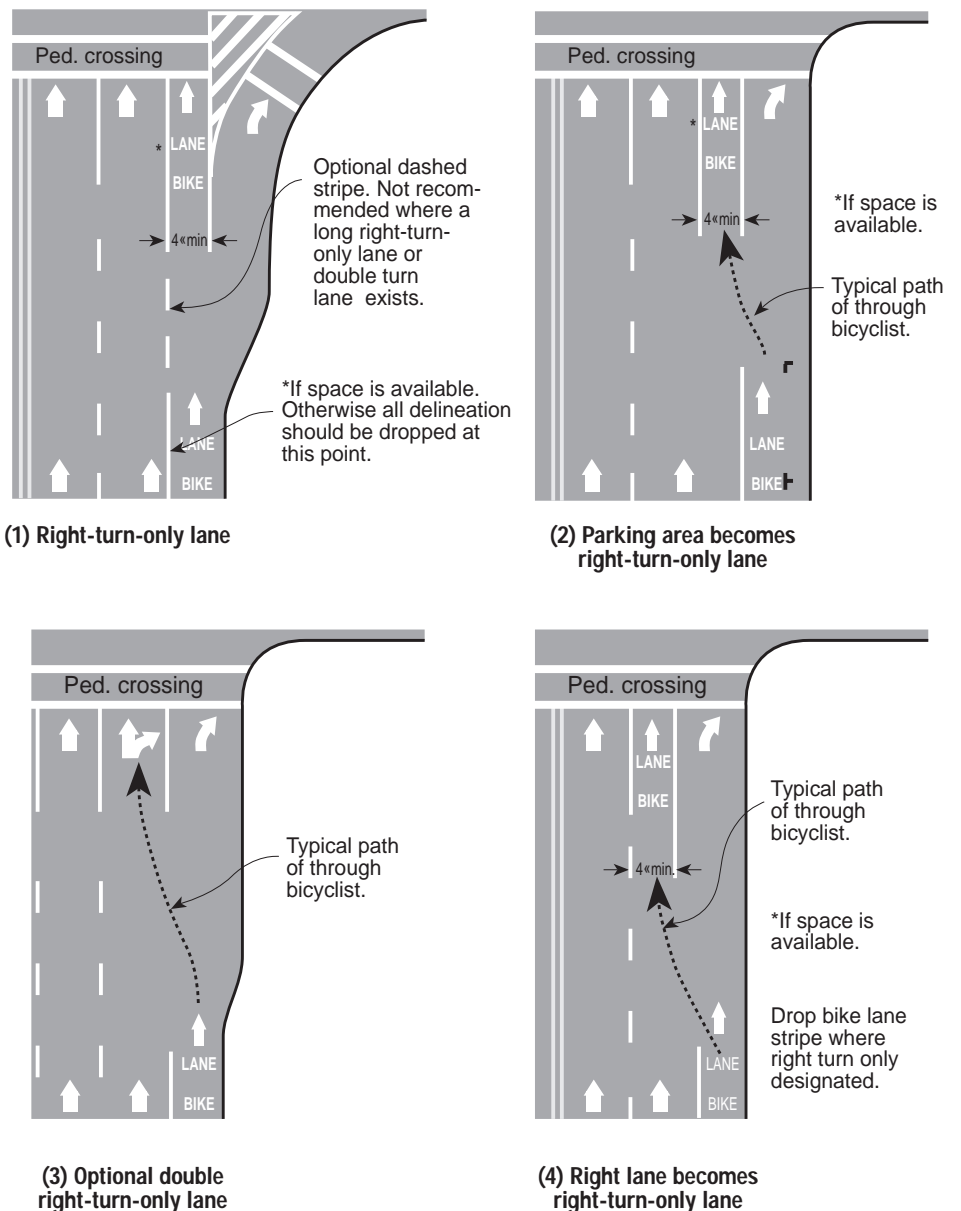



important than striping the lane on the rest of the block since it gives bicyclists a refuge away from turning traffic and encourages them to merge before the intersection.

**9. Parking:** Bicycle lanes should be to the traffic side of all curbside parking. Standard width parking spaces 2.4 m to 3.0 m (8 to 10 ft) wide should be provided and should, in general, not be narrowed to create the bicycle lanes. Such an approach can result in a dangerously close relationship between parked cars and bicycles.

Diagonal parking, because it requires motorists to back into traffic at an angle, does not work well with bicycle lanes. If a bicycle lane is moved away from the parking in order to provide clearance from backing motor vehicles, the combined parking/backing/bike lane area can take up an excessive amount of space. If the lane is striped close to the ends of the diagonal parking spaces, it puts bicyclists in jeopardy of being hit by backing cars. The best solution is to replace the diagonal parking with parallel parking and a bike lane.

**10. Signal actuation:** At traffic-actuated signals, special accommodation will be needed in the bicycle lane in order to ensure bicycle detection. Generally, this means a quadrupole loop buried in the bicycle lane near the stop bar at the intersection. If the bicycle lane is widened to accommodate right-turning motor vehicle traffic (as might be the case where, as in California, right-turning motorists are required by law to merge into the bike lane), then the loop should be a diagonal quadrupole to accommodate a wider range of bicycle positions. A loop marking might also be helpful.

## Wide curb lanes

A wide curb lane provided for bicyclists, while not technically a special bicycle facility, should conform to certain requirements nonetheless.

**1. Width:** A wide outside traffic lane should be 4.3 m to 4.6 m (14 to 15 ft) in width but studies have shown that bicyclists welcome any extra width beyond 3.6 m (12 ft) (MDDOT, 1984). Width should be measured from the lane stripe to the joint with the gutter (if any). Including the gutter pan

Figure 1.5  
Wide curb lanes  
implemented in two  
different situations  
Source: Lubbock Metropolitan Area  
Comprehensive Plan,  
Bicycle Federation of America

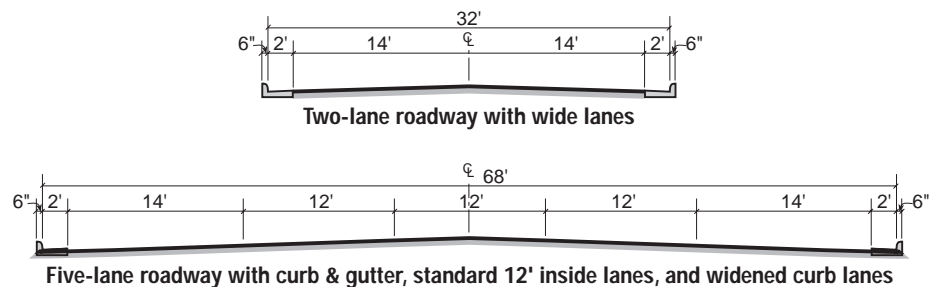

when determining the width of the outside lane is generally a mistake. The joint between the lane and the gutter is a hazard for bicyclists.

While widths greater than 4.6 m (15 ft) may give bicyclists even more room, excessive widths may encourage motorists to share the lane with each other side-by-side. This behavior is most likely to occur on the approaches to intersections with heavy volumes of right-turning traffic.

**2. Right turn lanes:** At intersections with right turn lanes, the extra width should be added to the right-most through lane. A short section of bike lane between the right-most through lane and the right-turn-only lane can also be a welcome design feature. As for the bicyclists making right turns, they can generally share a standard width lane with turning motor vehicle traffic. If, however, the right-turn-only lane is, in actuality, a high-speed merging lane, providing extra width there, as well, can help bicyclists and motorists coexist more peacefully.

**3. Signal actuation:** At traffic-actuated signals, special accommodation may be needed on the right side of the rightmost through lane in order to ensure bicycle detection. Options include installation of diagonal quadrupole loops in the right through lane or use of a pavement marking to identify the best location for detection (see the section of this report entitled “Traffic Signals” for more information).

## REFERENCES

- Evaluation of Wide Curb Lanes as Shared Lane Bicycle Facilities*, MDDOT, 1984
- Guide to the Development of Bicycle Facilities*, AASHTO, 1998 (pending)
- Manual on Uniform Traffic Control Devices*, FHWA, 1988
- Oregon Bicycle Plan*, Oregon Department of Transportation, 1992
- Selecting Roadway Designs for Accommodating Bicycles*, FHWA, 1994



# MINOR URBAN STREET TRAFFIC

## PROBLEM OVERVIEW

*Minor streets attract casual adult and child cyclists because these streets typically have low traffic volumes, low traffic speeds and serve residential areas.*



One of the most common complaints that local public works departments hear from community residents involves neighborhood traffic: either motorists go too fast on neighborhood streets or there is too much traffic or, most likely, both. These problems often arise as motorists use residential streets as bypasses for arterial streets. Sometimes exasperated agency personnel, upon investigation, learn that the cars are going less than the speed limit and volumes are within accepted norms. However, such conclusions often miss the point: if residents feel uncomfortable with their neighborhood's level of traffic or typical motorist speeds, then there is most likely a problem, whether or not it is severe enough to meet typical agency warrants for action.

Studies have shown that bicyclists, particularly youngsters, are most often involved in car/bike crashes on residential streets. These crashes tend to involve motorists driving lawfully. A question being asked more and more these days is whether it is truly appropriate to give priority to auto traffic in neighborhoods and for motorists to drive 25 mi/h through areas where children play and people of all ages live.

A study conducted in Australia produced the following findings:

- The higher the speed, the more drivers put the onus on the pedestrian or cyclist to get out of their way.
- The attitude of drivers at marked pedestrian crossings is “astoundingly ruthless.”
- Skills of judgment required to interact with traffic are only acquired by experience. Young children do not have these skills. Safety education is only of limited value—it cannot impart these skills. (“Children and Road Accidents;” Australian Bureau of Road Transport; 1985)

In addition, a study by Dr. Stina Sandels of Sweden concluded that “it is impossible to adapt small children fully to the traffic environment.” She argues that adults still blame children for accidents, calling them ‘careless’ whereas in reality the children have not developed the perceptual and cognitive skills necessary to handle traffic. She mentions four key factors: (1) play is a very important part of development; it is the business of children and must be factored into design; (2) children, being short, have trouble seeing what adults expect them to see; (3) children have trouble dividing their attention between that in which they are engrossed at the moment and the traffic to which they are supposed to pay attention; and (4) young children have difficulty understanding instructions and the somewhat arcane concepts that are integral to functioning in a traffic setting (in “Children in Traffic;” ed. by J. Hartley; 1975).

## SOLUTION OVERVIEW

Some local traffic problems can be solved through simple and inexpensive means like installing regulatory signs. Among the most popular are stop signs. Unfortunately, residents often expect too much from the installation of stop signs, which are intended to assign right-of-way between competing drivers. Studies suggest that, while stop signs can reduce right-of-way conflicts, they do little to reduce traffic speeds or volumes. Another popular idea, posting lower speed limits, also has little effect on drivers’ behavior, unless backed by a sustained enforcement effort. Similarly, the various warning signs (“Slow Children Playing” etc.) are unlikely to affect motorists’ actions.

Making certain streets one way can discourage through traffic, although speeds may increase. However, the idea must have the support of the neighborhood. In addition, one-way streets can have negative effects on local bicycle traffic. For example, a youngster who, before one-way street designation, could ride to a friend’s house a block away may find him/herself having to ride three or four blocks to reach the same destination after the street is designated one-way. As a result, wrong-way riding will likely increase when neighborhood streets are designated as one-way streets.

Some simple physical measures, on the other hand, can improve bicycling conditions on minor streets. For example, eliminating sight obstructions at key intersections can help motorists and bicyclists see each other in time to avoid conflict. Many communities have ordinances governing sight distance and these should be enforced.

To really make a difference in terms of traffic speeds or volumes on residential streets, it is necessary to use more serious measures. What is

needed is to change motorists' expectations and behaviors when driving in neighborhoods. The best way to do this is by significantly changing the environment. When motorists enter a neighborhood, they should see immediately that they are no longer on a thoroughfare. Using such traffic calming measures as diverters and partial diverters (see "Specifications" later in this section) can also help in the creation of bicycle boulevards, low-volume traffic-calmed streets that parallel major arterials.

*Simple physical measures, like this raised traffic circle, can improve bicycling conditions by slowing traffic and discouraging through traffic in residential neighborhoods.*



In general, standard subdivision design features like cul de sacs and curvilinear streets are not considered traffic calming techniques. Such approaches are seldom applicable in retrofit situations. And, while they undoubtedly reduce through motor vehicle traffic on specific residential streets, they also create barriers to bicycle travel and may well increase bicycling trip lengths, due to their circuitous nature. As a result, such design features are less desirable as traffic calming measures.



By increasing trip lengths and forcing bicyclists to use arterial streets to reach many common destinations, such designs as cul de sacs go hand-in-hand with increased reliance on motor vehicles. Studies from Portland, Oregon, for instance, show greater reliance on motor vehicles for most trips in such neighborhoods, when compared with more traditional grid designs (The LUTRAQ Alternative, 1992, Cambridge Systematics, Inc.).

Figure 2.1  
Cul-de-sac modified to  
increase options for internal  
bicycle circulation

It is possible, however, to modify the standard cul de sac design to somewhat increase the options for internal bicycle circulation. The diagram at right shows a short connector path between the ends of two cul de sac streets. While this approach can make very short intra-neighborhood trips more feasible, it does little for longer distance trips. And it is difficult to retrofit such a design to existing streets.

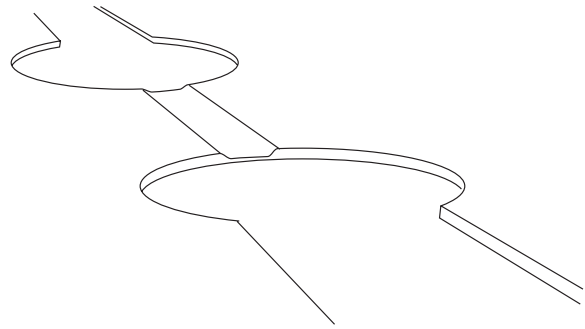

## OBJECTIVES

To reduce inappropriate levels of motor vehicle traffic and traffic speeds and encourage bicycle travel on residential streets:

- By working with neighborhood groups to identify traffic problem locations.
- By using appropriate traffic management strategies or installing traffic calming devices at key locations.

## IMPLEMENTATION STRATEGIES

Implementing traffic management strategies, like one-way street designation or traffic calming projects on existing neighborhood streets, should only be attempted with strong support from residents. Through extensive public involvement, it is possible to arrive at a consensus on a neighborhood's needs. Without residents' support, proposed solutions will likely be seen as attempts by agency personnel to run people's lives and will most likely be rejected by elected officials.

There are three primary strategies for implementing traffic management and calming measures. The first is to create a traffic management program with an annual budget and an explicit process for considering candidate projects. This approach allows an agency to consider projects from all parts of town in an impartial manner. It can also make the process understandable and acceptable for neighborhood residents.

The second approach relies on using unrelated projects to further neighborhood traffic management goals. For instance, adding a traffic calming feature to a planned repaving project could result in lower costs than implementing independent projects.

Third, implementing traffic management and traffic calming measures as a condition of development could reduce the impacts that new housing projects have on existing nearby neighborhoods. And, by requiring developers to cover the costs, it can reduce the burden on current residents and the community's taxpayers.

In all probability, some combination of the above strategies would serve the community best. A routine programmatic approach can help "institutionalize" consideration of neighborhood traffic problems. Adding "incidental" traffic management elements to a larger project can reduce costs and

allow the community to take advantage of opportunities. Requiring developers to deal with the traffic their work generates is a good way to solve problems before they occur.

## SUBTASKS

### 1. Develop a program

Set the program's budget to an amount that can ensure a relatively stable future: large enough to accomplish its purpose but small enough to keep it from becoming overly reliant on undependable income sources (e.g., grants). Create a reasonable process for project identification, selection, and implementation. Determine criteria for prioritizing potential projects, considering such elements as public support, costs, and current traffic impacts.

### 2. Identify problem areas

On the basis of public input and professional judgment, identify potential locations for attention. These might include residential streets used by commuters to circumvent nearby arterials, streets where drivers routinely speed, intersections with greater than expected numbers of crashes, as well as park and school sites. Determine whether unrelated transportation projects or other public works can help fund improvements. Move such improvements into the "fast track" in order to take advantage of the opportunities. For other locations, analyze and prioritize candidates according to criteria developed in Step 1 above.

### 3. Determine appropriate traffic calming measures

Depending on the particular problem involved, the street configuration, and the likely costs, identify the necessary measures for each site. Consider that, for traffic management to work, it should not merely shunt traffic from one residential street to another. For this reason, several locations in a neighborhood may have to be dealt with at one time. In selecting appropriate measures, it is important to work with neighborhood residents, as well as police and fire agencies. The latter must be involved to ensure emergency service for all affected locations.

#### *Sample problem and solution*

Consider the problem shown at right. To avoid a busy intersection at E, motorists cut through a nearby neighborhood as shown. As part of the solution, local officials installed partial closures at 1, 2, 3, and 4 and a raised center median on the north-south arterial between A and D. This eliminated most through traffic on the neighborhood streets. Some years after these measures were implemented, the intersection at E was also improved.

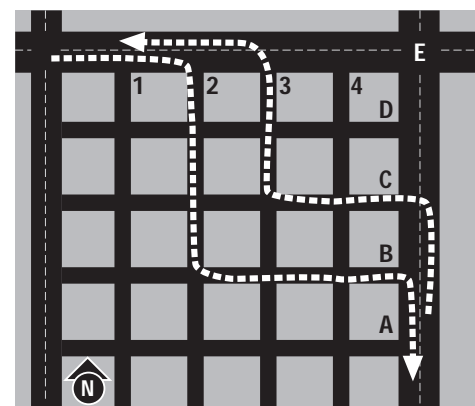

Figure 2.2

Diagram showing how through traffic may be reduced on through streets



## 4. Phase the development

With a good list of project sites and their appropriate traffic management measures, it is next important to create a phasing proposal for their development. The first phase may include a combination of: 1) critically important projects; 2) projects that can be included as incidental features of other planned projects; 3) projects whose opportunities may disappear in the future if they are not implemented soon; and 4) projects that can be easily accomplished.

Subsequent phases may include less critical projects, projects that may “ride along” on future transportation projects, and expansions based on new development.

## 5. Implement the system

Implementing a system of traffic management measures on minor urban streets, according to the phasing scheme, requires engineering design work, combined with the cooperation of street department personnel and continued public involvement to ensure acceptance. In some cases, input from sewer, police, and fire department personnel may also be necessary.

## 6. Evaluate the results

Keep track of the results of the program, as each project is implemented. Measure motor vehicle and bicycle traffic volumes before installation and after. Vehicle speeds should also be recorded before and after installation. A reduction in vehicle speed can be used as a measure of effectiveness. Speed is also needed to evaluate operations. Records of motor vehicle crashes, bicycle/motor vehicle crashes, and pedestrian/motor vehicle crashes should also be kept to determine the extent of safety improvements.

## RESOURCE REQUIREMENTS

In general, traffic management and traffic calming work requires small-scale construction projects. The physical resources (e.g., concrete, asphalt, signs) required for their creation are not as significant as the labor required to plan, design, and implement the improvements. Visiting communities with active programs and talking to designers can help agency personnel get up to speed and avoid common pitfalls.

## SCHEDULE

**Short-term:** Short-term projects include critically important locations, easy projects, and projects that can be treated as incidental aspects of current transportation projects.

**Long-term:** Long-term projects include more complex construction projects, perhaps involving projects that are likely to engender greater public concern (e.g., loss of on-street parking), and projects that will be completed as incidental parts of major transportation improvements.

## SPECIFICATIONS

While local agencies will likely be familiar with standard traffic management techniques, traffic calming measures are often less well-understood in the United States. The following table briefly illustrates some of the most common approaches.

## COMMON TRAFFIC CALMING TECHNIQUES

### Technique

### Definition

Figure 2.3 Traffic circle

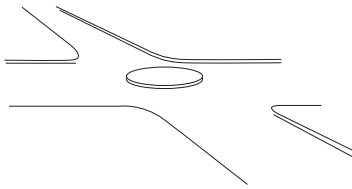

A raised traffic control device (see photo earlier in this section) located in the middle of an intersection to slow traffic. Usually, vegetation is planted in the center.

Figure 2.4 Speed hump or table

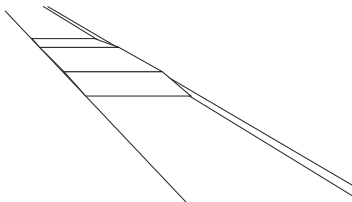

A section of raised roadway surface (2.4 m to 3.6 m [8 ft to 12 ft] long) that forces motorists to slow down. Not to be confused with speed bumps (typically less than 1 m [3 ft] long), often found in parking lots or mobile home parks, which can be a hazard to bicyclists.

Figure 2.5 Diverter

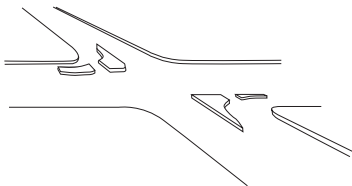

Structure placed at intersection designed to prevent through traffic by forcing motorists onto another street. They can be designed to allow bicyclists to ride past.

Figure 2.6 Partial street closure

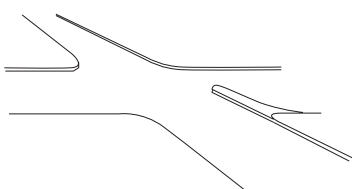

Access to a road is essentially eliminated in one direction through the use of a barrier across half the street. The rest of street remains two-way. They can be designed to allow bicyclists to ride past.

Figure 2.7 Street closure

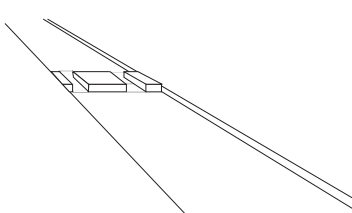

All through motor vehicle traffic is stopped by a curb-to-curb barrier. Slots are cut to allow bicycle traffic to get through. Can cause problems if motorists must use nearby driveways to turn around.

Figure 2.8 Curb bulb

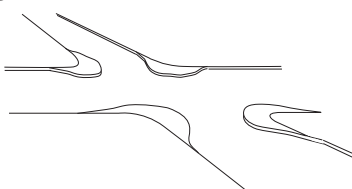

Sidewalk extensions at intersections narrow the road width and reduce crossing distances while increasing pedestrian visibility. Often used in downtown shopping districts and typically match the width of on-street parking.

Figure 2.9 Chicane

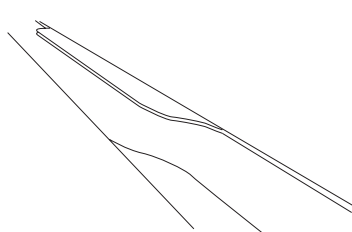

Obstacles (e.g., expanded sidewalk areas, planters, street furniture, or parking bays) are staggered on alternate sides of the roadway, requiring motor vehicle traffic stream to move side-to-side in the right-of-way.

Figure 2.0 Choke point

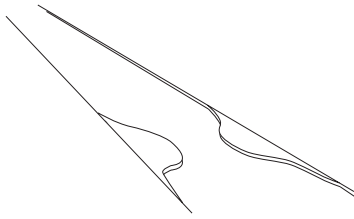

The narrowing of a street over a short distance to a single lane, forcing motorists to slow down and, occasionally, negotiate with on-coming traffic.

Figure 2.11 Gateway treatment

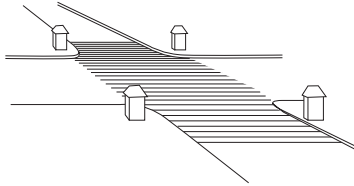

Raised intersection, surface alterations (such as brickwork or textured materials) that indicate a change from arterial to residential streets. Sometimes accompanied by signs showing the name of the neighborhood.

Figure 2.12 Woonerf

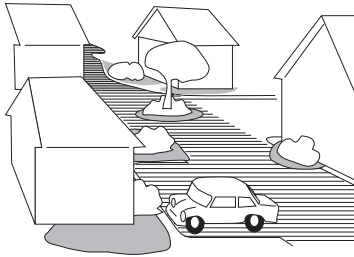

Dutch term meaning “living yard,” a street design strategy in which motorized and non-motorized traffic are not segregated and which grants pedestrians priority usage. May include the use of a variety of the measures described above.

## FOR MORE INFORMATION...

**Curb Bulbs**

Curb bulbs extend the sidewalk into the street. The bulbs, which may be landscaped, improve pedestrian crossings by providing better visibility between pedestrians and motorists, shortening the crossing distance, and reducing the time that pedestrians are in the street. Curb bulbs located at the intersection also prevent people from parking in a crosswalk or blocking a curb ramp. Curb bulbs may encourage motorists to drive more slowly by restricting turning speeds and narrowing the roadway.

**best used if**

- the intersection is used by many pedestrians
- the curb lane is a permanent, 24-hour parking lane
- a documented pedestrian/vehicle conflict exists involving turning vehicles.

**don't use if**

- curb lane is used as a travel lane, including lanes that are used for transit, or that have peak hour “no parking” signs
- right or left turn lanes are needed at an intersection
- large curb radii are required due to transit and truck turns
- extremely heavy parking demand (construction of a curb bulb may result in the loss of a parking space).

**estimated cost and funding**

Costs vary depending upon site conditions and design. SED funding exists for 10 to 20 curb bulbs per year. SED program funding levels change annually. Curb bulbs are prioritized based on pedestrian use and benefit.

**note**

Neighborhood plans should identify intersections that have high pedestrian use and could benefit from a curb bulb. If an intersection does not qualify for SED funds, the neighborhood could pursue the curb bulb through DON Matching Funds (see page 96).

**Check it out!**

See curb bulbs on Market Street in Ballard, and at 12th Avenue E, and Denny Way on Capitol Hill.

**Related case studies**

20th and Lane curb bulbs, page 116  
 Second Avenue—Belltown, page 106

works for: arterial streets  
 residential streets

making streets that work 49

One of the best references on traffic calming and management measures, complete with cost estimates and situations where particular measures are most appropriate, is Making Streets That Work: Neighborhood Planning Tool, a workbook for community groups interested in making changes to their own neighborhood streets. Written by staff from the City of Seattle, the book may be ordered from the

Seattle Engineering Dept.  
 Municipal Bldg. 600 4th Ave.  
 Seattle, WA 98104-1879  
 Cost is \$10.00.

---

## REFERENCES

- Children in Traffic*, ed. by J. Hartley, 1975
- Livable Streets*, Donald Appleyard, University of California Press, 1981
- Making Streets That Work: Neighborhood Planning Tool*, City of Seattle, 1996
- State of the Art: Residential Traffic Management*, Smith et al., USDOT/FHWA, 1980
- Traffic Calming, Auto Restricted Zones and Other Traffic Management Techniques*, Case Study 19, National Bicycling & Walking Study, Clark & Dornfield, USDOT/FHWA, 1994
- Traffic Calming: Planning Advisory Service Report No. 456*, Hoyle, American Planning Association, 1995
- Traffic Calming: The Solution to Urban Traffic and a New Vision for Neighborhood Livability*, CART, 1989
- Design Considerations for Pedestrian Sensitive Geometric Features*, Pietrucha & Plummer, in the Pedestrian Agenda, Bicycle Federation of America, 1993



# MINOR STREET/MAJOR STREET CROSSINGS

*The longer the bicycle trip, the more likely a bicyclist will have to cross a major arterial. For some, this can be an insurmountable barrier.*



## PROBLEM STATEMENT

Much of America's bicycling takes place on residential streets. However, the longer a bicycle trip is, the more likely it is that the rider will have to cross a major arterial thoroughfare. For some bicyclists, this is no challenge; but for others, it forms a nearly insurmountable barrier. As a result, many otherwise purposeful bicycle trips are cut short because the bicyclists "can't get there from here."

While this problem may exist to some degree in all parts of a community, it is generally most acute in newer residential areas. Such areas rely heavily on the hierarchical model of street designation, with residential streets feeding into collectors which, in turn, feed into arterial streets. As a result, residential streets may be literally devoid of traffic but arterials tend to be extremely busy.

In older parts of a community, a regular street grid can provide a variety of alternative routes for both bicyclists and motorists. As a result, the contrast between traffic on residential streets and that found on arterials is less severe and crossings often less difficult. Arterial streets in an older part of town may be three lanes of one-way traffic with parking on both sides and a curb-to-curb cross section of 15.8 m (52 ft). In such situations, crossing bicyclists can edge out into the intersection to see beyond the parked cars. As a result, the real crossing is reduced to 11.0 m to 12.2 m (36 to 40 ft).

By contrast, an arterial street in a newly developed area may have six through lanes, a center turn lane, two right turn lanes, and no parking for a possible curb-to-curb width of some 33.5 m (110 ft). And while traffic speeds on arterials in older parts of town may be 40 km/h to 48 km/h (25 to 30 mi/h), those on arterials in new areas may be 72 km/h to 88 km/h (45 to 55 mi/h).

## SOLUTION STATEMENT

There are several strategies for reducing crossing problems for bicyclists who use residential streets. One way is to encourage neo-traditional designs that include a combination of more compact and mixed land uses and a street system that more closely resembles a grid. A growing body of literature describes how this may be done (see References). Briefly put, this approach may require changes to zoning ordinances and re-education of local planners, engineers, developers, and residents. While such an approach may help a community avoid problematic arterial street crossings in the future, it doesn't help them deal with existing situations.

Since residential streets in many residential areas feed into collector streets, one important part of the solution is to improve collector/arterial street crossings. Such crossings should have bicycle-responsive traffic signals, adequate green time for casual riders to get across, and a reasonable amount of space on the collector streets for bicyclists to ride. Such streets are often excellent candidates for bicycle lanes and such measures can help attract riders who might otherwise use less desirable crossing locations.

At some residential street/arterial street intersections, the possibility of installing raised medians should be carefully considered, particularly in areas with potential bicycle and pedestrian cross traffic. Such medians can provide protection for non-motorized travelers, allowing them to cross one half of the roadway at a time in relative safety. Motor vehicle traffic access needs must be carefully considered, however.

## IMPLEMENTATION STRATEGIES

There are two primary strategies for improving minor street crossings for bicyclists. First, a field study of all collector/arterial street intersections should be conducted and improvements suggested as needed. Second, key residential street/arterial street intersections should be identified and modified. Factors in identifying such intersections would include public input, nearby bicycling attractors (parks, commercial areas, schools) and residential areas, adequate width on the arterial street, and the potential impact of eliminating left turns from the arterial to the residential street.

## OBJECTIVES

To provide safe and convenient means for bicyclists to cross arterial streets:

- By improving collector street conditions and collector/arterial intersections.
- By providing bicycle improvements at key residential street/arterial street intersections.

## RESOURCE REQUIREMENTS

Improving collector street conditions and collector street/arterial street intersections may require installation of bicycle-sensitive loop detectors and other relatively low-cost measures. Providing raised medians at key residential street/arterial street intersections will require construction and careful attention to safety considerations and may be controversial among residents. Extensive public involvement is critical.

## SUBTASKS

### 1. Survey collector streets and collector/arterial intersections

Through a field survey, identify needed improvements on collector streets and at collector/arterial intersections. Check out the responsiveness of traffic signals and measure curb-to-curb widths as background for possible lane marking changes.

### 2. Survey residential street/arterial street intersections

Identify intersections that serve important origins and destinations and determine whether nearby collector street/arterial street intersections can serve the need. If not, determine the feasibility of making crossing improvements to help bicyclists get across the arterial.

### 3. Prioritize locations by need

Based on potential use, identify those locations that are most likely to need improvements immediately and those that can wait. Put together a prioritized list of locations and the needed improvements.

### 4. Set up an on-going improvement program

Identify those problem locations that are likely candidates for inclusion in currently planned road construction or reconstruction projects and suggest adding bicycle features to those projects. Identify those locations that cannot be dealt with as “incidentals,” prioritize these, and budget a set amount for improvements each year.

### 5. Add bicycle improvements to the routine arterial street intersection design process

To keep future arterial streets from becoming major barriers to bicycle travel, make sure that the crossing needs of bicyclists are considered in the standard thoroughfare design process.

### 6. Evaluate results

On at least an annual basis, determine what progress has been made toward the goal of providing ways for bicyclists to cross arterial streets. Consider the number of intersections treated, the number of locations left to be improved, and the proportion of new locations that accommodate bicyclists .



## SCHEDULE

This program requires an on-going effort to incrementally eliminate arterial street barriers to bicycle traffic. It requires an on-going commitment to making bicycle-related improvements part of the routine business of road building and renovation.

## SPECIFICATIONS

### Collector street/arterial street intersections

Providing bicycle lanes on collectors may require rethinking current striping. For example, eliminating a turn lane may allow restriping for bike lanes. Bicycle lanes should be equipped with sensitive loop detectors as described elsewhere in this manual. Further, signal timing should be adjusted to allow crossing bicyclists to clear the intersection. Bike lanes should merge to the left of right turn lanes.



*Improving conditions for cyclists at signalized intersections may require installation of bicycle-sensitive loop detectors.*

### Residential street/arterial street intersections

At locations where a raised median can be provided, a careful design using curb cuts and short connecting paths can be combined with appropriate warning and regulatory signs to accommodate crossing bicycle traffic

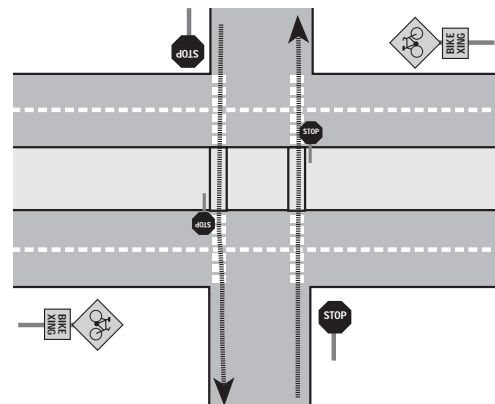

*Figure 3.1*

*Curb cuts and short connecting paths can accommodate crossing bicycle traffic at raised medians.*

(Bicycle Federation of America, 1995). Such a design can work well as part of a “bicycle boulevard” approach, which involves making bicycle-friendly and traffic calming improvements to a residential street that parallels a major arterial.

## REFERENCES

- Guide to the Development of Bicycle Facilities*, AASHTO, 1998 (pending)
- Lubbock Metropolitan Area Comprehensive Bicycle Plan*, Bicycle Federation of America, 1995
- North Carolina Bicycle Facilities Planning and Design Guidelines*, NCDOT, 1994



# OVERCOMING BICYCLING BARRIERS

*Eliminating a physical barrier, or providing a way for bicyclists to go around, over, or under such barriers, has the potential for significantly increasing the number of bicycle trips.*



## PROBLEM OVERVIEW

In many cases, implementing a community bicycle plan includes dealing with substantial physical barriers. It is often the case that a potentially important destination for bicyclists may be separated from nearby residential areas by a river, an interstate freeway, a railroad line, or some other major obstacle. For bicyclists, the saying “you can’t get there from here” is, sadly, often true.

The importance of such barriers becomes clearer in light of typical bicycle trip distances. Because bicyclists are “self-powered,” many of their trips are limited to 1 or 2 miles in length. In fact, according to the 1995 Nationwide Personal Transportation Survey, the average length for a bicycling trip is just under 2 miles. Therefore, a barrier that adds a mile or two to a bicycle trip may put the destination out of reach for most bicyclists. Conversely, eliminating a major barrier has the potential for increasing the number of bicycling trips significantly.

Forming the connection between origin and destination—breaking the barrier—can be a major challenge. In some cases, it is possible to take advantage of existing roadway connectors. For example, re-striping the travel lanes on a roadway bridge can be used to create bicycle lanes. In many cases, providing such on-road facilities can help bicyclists reach the

popular destinations commonly found on collector and arterial streets. See the “Roadway Bridge Modifications” section for on-road options.

If an independent structure like a bridge or underpass is required, costs can be substantial. Or there may be conflicts over land ownership, agency or company policies, and jurisdiction. For instance, one agency in Massachusetts recently built a bicycle/pedestrian trail with a 15.2-m (50-ft) gap where the trail crosses a railroad line. The railroad company and the agency could not agree on a plan of action.

## SOLUTION OVERVIEW

One way of breaking bicycling barriers is through physical improvements, like bridges or underpasses. While they can be among the most expensive parts of a system, they can substantially increase the utility of a trail or street network.

In some cases, such structures have been built independently of any roadway facility. This ensures that the structure is located just where it is needed. Because the location can be carefully chosen, this approach can also eliminate conflicts with major corridor traffic. The structure can be a major crossing, like the bridges shown in the top two photos at right. Or it can be an underpass beneath an arterial street like that shown in the third photo.

Sometimes, independent structures can be provided in conjunction with solutions for other community needs. For instance, several bicycle/pedestrian bridges have been



combined with utility crossings. In other cases, structures have been added to existing or planned transportation facilities.

For instance, bicycle bridges have been added on one side of a highway bridge, as shown in the fourth photo, or underneath a transit bridge, as shown in the last photo. These approaches are most easily done when a major structure is being built or renovated. In such cases, they can be handled as incidental features of a large project. It's important, however, to carefully evaluate such options. Some existing bridges will not support the eccentric loads imposed by cantilevered bike-pedestrian bridges. And structures hung underneath a bridge must allow sufficient clearance for flood waters or highway or train traffic, depending on the circumstances.

In extreme cases, agencies may provide services that circumvent the problem. For example a shuttle might take bicyclists across a major waterway, as has been done in several areas. Because such cases are much less common than those discussed above, this report will not go into detail on the subject.

## OBJECTIVES

To overcome important bicycling barriers:

- By providing bicycling improvements to existing or planned roadway bridges (see the section entitled “Roadway Bridge Modifications” for details).
- By providing independent bicycle/pedestrian structures where necessary.
- By combining bicycle/pedestrian structures with other existing or planned transportation facilities.

## IMPLEMENTATION STRATEGIES

Overcoming physical barriers to bicycling involves first identifying and prioritizing those that are most important. The next step is to determine how to overcome each one and develop approximate cost estimates. Some barriers are easily bridged but are relatively unimportant while others may be exceedingly difficult but are very much needed.

Setting priorities for solutions involves balancing public input, gathered through meetings, media outreach, and other means, with an analysis of the potential good to be achieved. For instance, if a small but vocal group proposes a bridge over a major river but the structure would serve few potential users, this project may deserve a lower priority than one that would link a major residential area with a large park, school, or shopping area. Area-wide surveys can help determine potential support for a particular structure.

Finally, because of the costs involved in major construction, it is always important to investigate all potential means of solving the bicycling problem—perhaps through some sort of combined project or by modifying an existing roadway structure. Evaluate those existing structures carefully. In some cases, a simple restriping combined with surface improvements will provide a critical link.

If no such link exists, find out who else could benefit from a crossing and who may be already planning a major investment that could help break the

bicycling barrier. The City of Eugene, Oregon, for example, has worked with utility agencies to combine water lines with bicycle-pedestrian bridges over the Willamette River. Seattle, Washington, has worked with communications companies to combine fiber optic lines with trail corridors.

## SUBTASKS

### 1. Identify bicycling barriers

With a map of the community, identify barriers like rivers, railroad yards or tracks, interstate freeways, creeks, and canals. Focus particular attention on those barriers that separate residential areas from potentially popular destinations (parks, shops, schools, work centers). Examine existing crossings (if any exist) in terms of their suitability for bicycling. It may be that the only way across a particular river, for instance, is over a narrow, busy, high-speed bridge with a hazardous deck. On the other hand, the structure may hold promise if suitably modified.

### 2. Prioritize the barriers

Some barriers deserve a higher priority than others. Highest priority barriers would include: 1) those near areas with high levels of existing bicycle use or evidence of potential bicycle use (e.g., lots of families living nearby or potentially popular destinations); 2) those identified by bicycling interests as major problems; 3) those with evidence of related safety problems; and 4) those that isolate communities that are traditionally underserved. Lowest priority barriers would be: 1) those seldom mentioned by bicyclists; 2) those far from potential users; and 3) those broken by other nearby (and relatively suitable) structures.

### 3. Determine likely alternatives

Determine how the barriers might be broken. A river or creek would need a bridge while a raised interstate freeway would probably require an underpass. Identify streets or trails that the structure would (or should) connect. Look at traffic volumes, speeds, and physical characteristics of the streets to determine their suitability for a connection. For the most part, a special bicycle-pedestrian bridge or underpass should link smoothly with the trail and road network on both sides with no hazardous conditions. In other words, it should not dump users out onto a major arterial street. Get a rough approximation of distances to be crossed, elevation changes, and any physical constraints (e.g., locations of interchanges, historical buildings that can't be moved, or sensitive natural areas). Look at the possibility of using existing or planned structures in some way. Finally, get a general idea of costs for budgeting purposes. In these steps, it is particularly useful to work with an engineer with a background in structures. He or she can help determine whether, for example, prefabricated bridges or culvert-type underpasses might be useful.

### 4. Prioritize projects based on feasibility

With information gathered during the previous step, revisit the priority listing of barriers and determine whether any changes are needed. Quite possibly, a lower priority barrier may be easily broken while a high priority barrier may be nearly impossible to bridge.

## 5. Phase the development

With a prioritized list of barrier-breaking projects in hand, it is next important to develop a phasing proposal for development. Depending on available funds, early phases may include a combination of: 1) critically important structures; 2) structures that can be included as incidental features of other planned projects; 3) existing structures that can no longer serve motor vehicles and may be demolished in the future; and 4) structures that can be easily and cheaply built.

Subsequent phases may include less critical connections, projects that may “ride along” on future transportation projects, and expansions based on new development.

## 6. Implement the projects

Building a series of barrier-breaking bicycle structures according to the phasing scheme requires detailed engineering design, combined with sensitive construction work and continued public involvement to ensure a fit between the public’s needs and the projects’ characteristics. Members of the public may initially worry that breaking a bicycling barrier may bring “undesirables” into their neighborhoods. Such real but unwarranted concerns, along with others, must be seriously addressed throughout the development process.

In addition, it is important that projects be designed according to the most current information. In particular, adequate consideration of such details as widths and clearances, railings (if any), grades, visibility on curves, and lighting are critical to the project’s success. Because structures are so costly to begin with, it is unlikely that initial mistakes (e.g., making a bridge too narrow for safe two-way bicycle use) will be fixed. The additional cost involved in doing it right the first time is far smaller than the cost of changing a structure at a later date.

Finally, it is important to consider maintenance as part of the implementation phase. Someone will have to sweep the structure, replace light bulbs, and attend to myriad details for years to come. The responsibility for these duties must be determined before the structure is built.

## 7. Evaluate the results

Keep track of the results of the projects. Measure bicycle traffic volumes on a regular basis. Consider installing loop detectors that can be wired to counters; these can count bike traffic unattended on an on-going basis. Also look at how popular the structures are and whether there are important problems with vandalism or other crimes. Identify any changes in bicycle traffic patterns resulting from a structure’s installation that may require modifications of other parts of the system.

## RESOURCE REQUIREMENTS

In general, the resources required for designing, building, and maintaining bicycle structures are significant. Money and expertise are the primary requirements. The former need can be met by including projects in the Transportation Improvement Program and prioritizing them according to their importance. The latter need can be met through the use of engineering and planning staff or consultants.



Since virtually all communities have structures of some kind—generally motor vehicle bridges or underpasses—the expertise to build bicycle structures is already in place. The primary extra requirement is familiarity with such documents as the AASHTO *Guide for the Development of Bicycle Facilities*.

## SCHEDULE

**Short-term:** Since most projects will require allocation of substantial sums of money, detailed engineering, and an environmental impact assessment and public involvement process, few are likely to be accomplished in the short term. However, some opportunities for immediate action may include easy retrofit projects and projects that can be treated as incidental aspects of current transportation projects.

**Long-term:** Long-term projects include more complex construction projects, projects that are likely to engender greater public concern (e.g., loss of on-street parking), projects that may involve significant environmental effects, and projects that will be completed as incidental parts of future transportation improvements.

## SPECIFICATIONS

Bicycle structures should conform to the AASHTO *Guide for the Development of Bicycle Facilities* (1991). In addition, the following basic points should be considered. Special circumstances may require deviating from these suggestions.

### Bicycle bridges

**1. Width:** The width of a bicycle bridge should be equal to that of the approaching path plus the clearances on either side. With a 3-m (10-ft) path and 0.6-m (2-ft) clearances on either side, this would result in a bicycle bridge width of 4.3 m (14 ft). If significant pedestrian traffic is expected, or if users are likely to stop on the bridge to view the scenery, extra width should be considered.

**2. Railings:** Bridge railings should be a minimum of 1.4 m (4.5 ft) high to keep bicyclists from pitching over the top in case of an accident. A rub rail at handlebar height can improve safety as well. Approach railings should be angled away from the edge of the path to reduce the potential that a bicyclist could hit it head-on.

Figure 4.1

Bridge cross section

Source: adapted from Lubbock Metropolitan Area Comprehensive Plan, Bicycle Federation of America

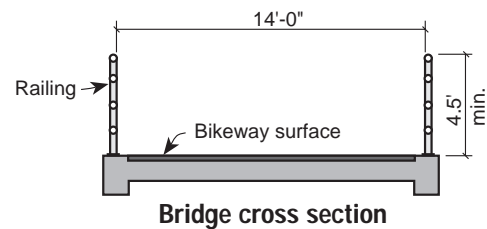
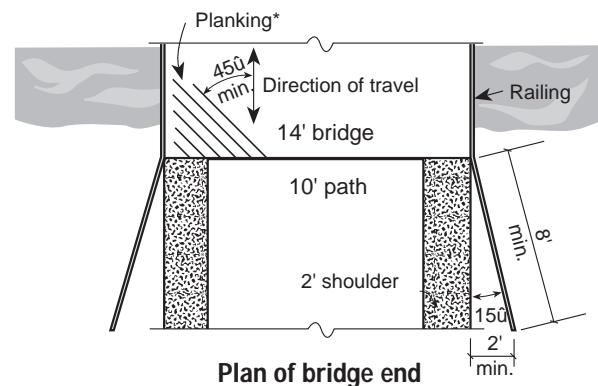

Figure 4.2

Plan of bridge end

Source: adapted from Lubbock Metropolitan Area Comprehensive Plan, Bicycle Federation of America



\*If planking used, it must be laid at least 45° to direction of travel.

*RELATIVELY INEXPENSIVE BRIDGES*

A custom-designed structure is not the only solution to providing a bicycle bridge. A growing number of companies design and build prefabricated bridges to serve a wide variety of needs, from crossing water hazards at golf courses to carrying pedestrians across major arterial roads. Such pre-fab bridges are designed and assembled to a customer's specifications at a company's factory and then shipped to the site by truck.

The companies below provide a variety of structures made from different materials:

- Continental Bridge Company, 8301 State Highway 29, N., Alexandria, MN 56308
- EnWood Structures, PO Box A, 5724 Koppers Rd, Morrisville, NC 27560
- E.T. Techtonics, 2117 Tryon St., Philadelphia, PA 19146
- Excel Brige Mfg. Co., 1200 Shoemaker Ave, Santa Fe Springs, CA 90670
- Steadfast Bridges, PO Box 806, 281 40th St NE, Ft. Payne, AL 35967
- Western Wood Structures, PO Box 130, Tualatin, OR 97062

Some companies use steel for their prefabricated bridges, others use glulam wood beams. Clear spans run from 6 m (20 ft) to 76.2 m (250 ft), depending on type of bridge. Several spans can be combined to form a longer bridge through the use of intermediate supports. Using short spans and lots of supports, however, may or may not be the way to go. The expense of a beefier structure for a long clear span must be weighed against the expense of providing extra piers in a river, for instance.

A couple of important factors to consider when getting cost estimates:

- Railing heights must be 1.4 m (4.5 ft).
- Minimum width should be 4.3 m (14 ft); in low-volume situations 3 m (10 ft) may suffice.

*Other inexpensive bridge options*

In some instances, it may be possible to implement a bike-pedestrian bridge project for very little money. At least three techniques suggest themselves:

1. Farmers have long known the value of old railroad flatcars as short bridges. The trick is that your needs, in terms of span, should at least roughly correspond to the distance between the flatcar's front and rear wheel assemblies.

This distance can vary up to about 27.4 m (90 ft) long. So shop around for one that's the right length. Used flatcars can sometimes be had for between \$3,000 and \$6,000. Keep in mind that there will be extra costs, beyond the price of the flatcar. You will probably have to truck it to your site and lift it into place; it will need a deck and railings. And you'll have to design piers.

2. As rail lines are abandoned or improved, railroad companies sometimes stockpile materials from bridges for future use. You may be able to talk the company into either donating the bridge parts to your cause, or giving them to you at a good price. If you have non-profit status, a donation can give them a nice tax deduction!

3. Consider an old motor vehicle bridge that can no longer serve its intended purpose. In some cases, these bridges can be moved to a new site; in others, the replacement bridge is built elsewhere, leaving the old bridge in place. Either way, such bridges can often be retrofitted to serve bicycle traffic for a small amount of money.

**3. Surface:** A relatively smooth non-skid surface should be installed to reduce the potential for sliding under wet conditions. If planking is used, boards should be installed at least 45 degrees to the direction of travel and any curl should face down.

**4. Approaches:** Bridge approaches should have good visibility; bicyclists exiting a bridge should be able to see bicyclists approaching the bridge, and vice versa. Grades should be no greater than the requirements set by the Americans with Disabilities Act (U.S.A.T.B.C.B., 1994). If barrier posts are used to keep motor vehicle traffic off, they should be brightly painted and reflectorized and should be installed in a well-lit area.

**5. Lighting, visibility, and security:** Bridges should be well-lit for safety and personal security reasons. In addition, it is desirable that bridges be visible from adjacent populated areas, buildings, or roadways to allow police patrols and others to easily see what is going on.

## Attached bicycle bridges

**1. Width:** The suggested width for an attached bicycle bridge is the same as that for an independent bridge: 4.3 m (14 ft). For a

short span, a narrower cross section may be adequate, particularly if low volumes of bicycle traffic are likely. If the width available is very limited, such as 1.8 m (6 ft), consider adding such a structure for one-way traffic to each side.

**2. Separation and clearances:** There should be a physical separation between the bicycle bridge area and any adjacent travel lanes. For a bridge suspended below a roadway or railroad bridge, vertical clearances should be a minimum of 2.4 m (8 ft). If maintenance vehicles will use the bridge, clearance should be increased to 3.0 m (10 ft).

**3. Railings:** Bridge railings should be 1.4 m (4.5 ft) high. A rub rail at handlebar height is also recommended.

**4. Surface:** The decking should be relatively smooth but non-skid. If the bicycle bridge is adjacent to the roadway bridge, savings may be achieved by creating a contiguous surface and installing the barrier later. Concrete or asphalt surfaces are preferable to steel decking.

**5. Approaches:** If a bicycle bridge is attached on one side of a motor vehicle bridge, the approaches should be designed very carefully. The best solution is to provide connecting pathways that take bicycle traffic to nearby quiet streets or independent trails. This eliminates the likelihood of introducing crossing or contra-flow bicycle traffic at bridge ends. If the bicycle bridge is underneath the roadway bridge, traffic considerations are likely to be insignificant; however, grades may require attention.

**6. Lighting, visibility, and security:** Lighting from an adjacent roadway bridge is likely to serve bicyclists well. If the bicycle bridge is suspended under another bridge, special consideration should be given to providing adequate

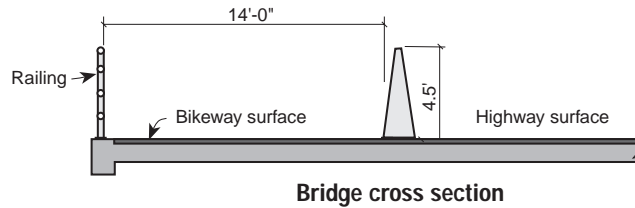

Figure 4.3

Bridge cross section

Source: adapted from Lubbock Metropolitan Area Comprehensive Plan, Bicycle Federation of America

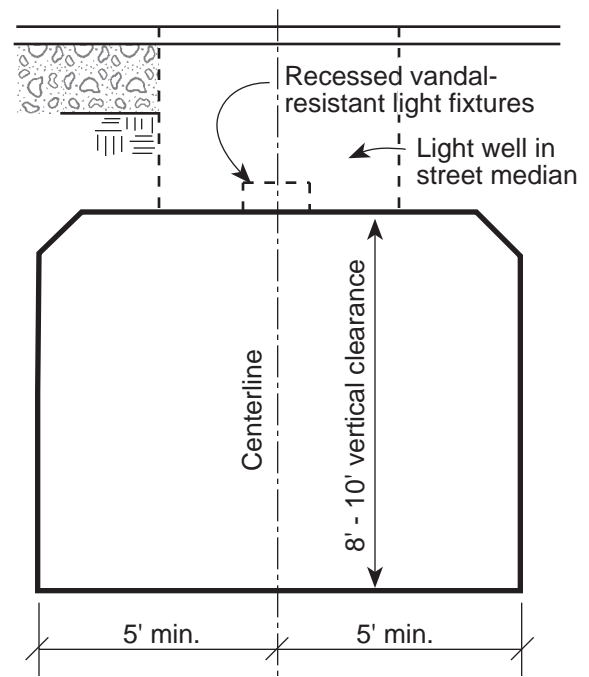

Figure 4.4

Lighting for a bicycle underpass

Source: adapted from Lubbock Metropolitan Area Comprehensive Plan, Bicycle Federation of America

visibility. In some cases, police bicycle patrols may need to visit the facility on a regular basis.

**7. Structural considerations:** Careful attention must be paid to whether the bicycle structure can be safely added to an existing bridge. Cantilevering a facility on one side of a highway bridge, for instance, may introduce loading conditions for which the structure is unsuited.

## Bicycle underpasses

**1. Width:** Ideally, the minimum width of a bicycle underpass should be equal to that of the approaching path plus the clearances on either side. With a 3-m (10-ft) path and 0.6-m (2-ft) clearances on either side, this

### FACTORS IN DECIDING BETWEEN UNDERPASSES & OVERPASSES

The choice between an overpass and an underpass depends on a variety of factors.

1. Relative elevations: Depending on what must be crossed (e.g., a river, a freeway, a railroad yard) and its elevation compared with that of the possible bicycle connections, an overpass may or may not be preferable to an underpass. For the most part, water features will be crossed with a bridge and the clearance below the structure will be determined by such factors as flood levels and the necessity to allow watercraft to pass underneath. Elevated freeway sections, by contrast, may be best dealt with by providing an underpass. When freeways must be crossed via an overpass, the structure must allow for the passage of large trucks; 6.1 m (20 ft) of clearance may be required. Railroad tracks, particularly those where “piggy back” cars must be accommodated, require 7.3 m (24 ft) of clearance. Underpasses, by contrast, need not have such large clearances since the heights involved are those of bicycle users. A ceiling height of 2.4 m to 3 m (8 to 10 ft), in most cases, is all that is needed, depending on whether maintenance vehicles must be accommodated.

2. Grades and the Americans with Disabilities Act: Since most bicycle structures are, in actuality, multi-use structures that must accommodate pedestrians, the Americans with Disabilities Act, or ADA, is an important factor to consider. ADA governs maximum grades for ramps (1:12) and requires a level landing for every 0.7 m (2.5 ft) of rise (U.S.A.T.B.C.B., 1994). In some cases, these considerations may result in very long ramp structures. For example, to reach the deck of an overpass with a 7.3-m (24-ft) clearance, over 106.7 m (350 ft) of ramp would be required. Depending on available land, an underpass may be the most feasible way to cross a particular barrier.

3. Grades and ease of bicycling: To some extent, it is easier for a bicyclist to use an underpass than an overpass. The reason is simple. A bicyclist entering an underpass gains speed as he/she descends and, in some cases, can almost coast up the exit ramp at the other end. By contrast, a bicyclist must climb an overpass first, using energy in the process, and then can coast down the other side. Descending first can result in a possible savings of energy and an easier ascent. At the same time, it is important to consider the implications of speed when designing either an underpass or an overpass.

For example, a bicyclist entering an underpass may decide to pedal fast down the slope in order to ease the climb at the far end; as a result, bicycle speeds may be higher than expected and the potential for crashes in the underpass itself should not be ignored. With an overpass, it would be important to consider the potential speeds of bicyclists coming off the structure and design trail connections and intersections accordingly. Ending the ramp at a curb cut on a major roadway would be a serious mistake. It would be better to connect the ramp to a generally flat trail segment with no more than gentle curves.

Beyond the choice between an underpass or overpass, grades can also determine how much use a structure gets. Bicyclists may choose an alternate route that has somewhat more challenging conditions (e.g., higher levels of traffic, higher speeds, or worse surface conditions) if they perceive the climbing involved in using the structure to be excessive.

4. Sense of danger: Many people are less comfortable going through an underpass than they are using an overpass. This is particularly true if the underpass is long or dark or has geometric features that either offer hiding spots for muggers or block the view through to the outside at the other end. Since an underpass typically offers shelter from the weather, it can become a gathering place for people, and a bicyclist will have to pass through or near them. This can be disconcerting and some bicyclists will avoid using an underpass for this reason. An overpass, by contrast, can generally be seen from nearby areas and a person in trouble would have a greater chance of attracting attention than he or she might in an underpass.

5. Weather: On the other hand, the sheltering aspect of an underpass can reduce the impacts of weather on the bicyclist. An overpass in the Snow Belt may need to be plowed during the winter and ramps may need to be sanded for safety.

6. Potential hazards for others: An overpass presents an opportunity for mischief as well. If, for example, it crosses an interstate highway or a high-speed railroad line, some people may throw objects from the overpass onto users below. While design features can mitigate the problem, it is important to consider potential vandalism when considering a particular site for an overpass.

would result in a minimum underpass width of 4.3 m (14 ft). A narrower width may be acceptable for a very short structure; however, the longer the underpass, the more unpleasant and unattractive a narrow structure will be. A width greater than 4.3 m (14 ft) may be necessary if the underpass is likely to be well-used or if significant pedestrian traffic is anticipated. Vertical clearances should be at least 2.4 m (8 ft); 3 m (10 ft) may be required if maintenance vehicles must use the structure.

**2. Surface:** A relatively smooth non-skid surface should be installed to reduce the potential for sliding under wet conditions. Drainage should be carefully considered; standing water (or, possibly, ice) should not be allowed to accumulate in the structure but should, rather, be dealt with through appropriate drainage features.

**3. Approaches:** Underpass approaches should have excellent visibility; bicyclists exiting should be able to see bicyclists approaching, and vice versa. In addition, bicyclists entering one end should be able to see all the way through the underpass for personal security reasons. Grades should be no greater than the requirements set by the Americans with Disabilities Act. If barrier posts are used to keep motor vehicle traffic out of the underpass, they should be brightly painted and reflectorized and should be installed in a well-lit area.

**4. Lighting, visibility, and security:** Underpasses should be extremely well-lit for safety and personal security reasons and lighting should be vandal-resistant. In some cases, police bicycle patrols may need to visit the facility on a regular basis. If the underpass is long (for example two bridge structures with two lanes each), passive lighting can be provided by opening up the “ceiling” of the underpass in the space between the structures. Drainage must be considered if such openings are provided.

## REFERENCES

- Guide for the Development of Bicycle Facilities*, AASHTO, 1998 (pending)
- North Carolina Bicycle Facilities Planning and Design Guidelines*, NCDOT, 1994
- Arizona Bicycle Facilities Planning & Design Guidelines*, AZDOT, 1988
- “A Second Look at Bridges,” John Williams, *Bicycle Forum*, 1995
- Americans With Disabilities Act (ADA), Section 14, “Public Rights-of-Way Interim Final Rule,” *Federal Register*, Vol. 59, No. 117, June 20, 1994, U.S. Architectural & Transportation

# TRAIL NETWORKS



*Bicyclists prefer low-stress environments. In many cases, the least stressful environments are found on trails separated from traffic.*

## PROBLEM OVERVIEW

**M**any bicyclists prefer riding in low-stress environments. Such environments can often be found on residential streets. But, in many cases, the least stressful environments are found on separate trail systems. Yet, because such facilities are often in short supply, bicyclists must often travel long distances to reach trailheads and may well encounter very high levels of bicycle and pedestrian traffic once they arrive. As a result, the low-stress travel experience they were expecting ends up being a stressful encounter with hoards of other non-motorized travelers.

## SOLUTION OVERVIEW

Creating a more complete network of trail opportunities can bring those facilities closer to a greater number of potential users and can help spread use over a larger system. As a result, more people will be able to ride trails and do so with less congestion.

## OBJECTIVES

To develop an extensive network of off-road facilities to serve a greater number of users and reduce use-related impacts on specific sections:

- By developing new trails where possible throughout the community.
- By connecting existing trail segments.
- By encouraging or requiring developers to include trail segments in their work.

## IMPLEMENTATION STRATEGIES

There are two primary approaches to implementing a trail network. The first approach is to aggressively go after potential corridors (e.g., railroad lines, utility easements, waterway corridors, and linear park opportunities) and build new trail segments whenever the opportunity arises. The second is to implement regulations that require developers to build trail segments or at least provide dedicated rights-of-way in their developments when doing so will extend an existing trail network or may possibly do so in the future—or may provide for internal off-road circulation.

## SUBTASKS

### 1. Develop a “broad brush” conceptual trail network map

Taking advantage of existing or potential corridors, develop an overview of the future trail network that, to the extent possible, connects the different neighborhoods and major attractors of the community. Where necessary, keep route selection generalized in order to allow some deviation when unexpected opportunities arise. Get this conceptual plan adopted by the local governing body.

### 2. Identify key specific trail corridors that can be the focus of initial attention

There may well be one or two particular corridors that can serve as the starting point of a trail network. These should combine a balance of relative ease of implementation, attractiveness, and maximum utility. For instance, while some potential corridors may be easily secured, they may exist far from any likely user base. For this reason, users will have to travel long distances just to reach the trail. On the other hand, a corridor that is close to residential areas may not serve a purpose. In either case, low numbers of trail users may doom future extensions of the system.

### 3. Work to implement trails in those initial corridors

Developing trails in those key corridors will first require the acquisition of either property or an easement. Once the land is secured, design can proceed and should be based on the references found at the end of this section.

Budgeting adequate funds for trail development is important. Many examples of underfunded trails exist around the country and these are typified by substandard widths, clearances and geometrics, narrow structures, lack of continuity, and inadequate attention to other hazardous conditions. It is generally best to build shorter, high-quality trail segments than longer segments that stretch the limits of the budget and ignore available design standards.

#### 4. Create a mechanism for implementing trails as conditions of development

It may be necessary to change development regulations to require developers to include trails in their plans. However, it is often the case that once they see the commercial benefits of trail development, they will include them without question. It is still important in such cases, however, that developers' trail networks mesh with that of adjacent land owners and the overall system.

#### 5. Prioritize future trail development needs and budget for a long-term investment

Once initial trails have been built and a constituency begins to grow, interest in future trail projects will likely grow as well. A detailed workplan should be assembled that will involve sequential implementation of the overall network over a period of years. A budget for the program should be established and appropriate agency staff should be placed in charge of the program.

#### 6. Evaluate the results

Keep track of the results of the program, as projects are implemented. Keep track of the number of miles of trail developed and identify gaps in the system that need to be bridged. Measure bicycle use throughout the process. It may be useful to install bicycle counters in the trail surface at key locations in order to keep on-going records of use. Survey users regarding their satisfaction with the improvements and their ideas for future work. In addition, on a routine basis identify hazardous locations and crash sites and identify necessary measures to solve such problems.

## RESOURCE REQUIREMENTS

There are two primary resources required for a trail network. First is land in the form of linear corridors and this may be assembled through a variety of means. The second is the wherewithal to build and maintain the facilities. Many parks departments are equipped to handle these tasks.

## SCHEDULE

**Short-term:** Short-term projects include trails in easy-to-implement corridors that connect to bicycle-friendly streets or other trails. These will likely be few in number but can help build support for the long-term effort. Another short-term project may be the initial conceptual trail network design.

**Long-term:** Long-term projects include assembling extensive trail corridors and modifying regulations to require or encourage developers to participate in the process.



## SPECIFICATIONS

### Trail design

The AASHTO *Guide* recommends a paved width of 3.0 m (10 ft) for a two-way directional shared use path. Where substantial use by bicyclists, joggers, skaters, pedestrians, or large maintenance vehicles is expected or where steep grades are encountered, it may be necessary or desirable to increase the width of a shared use path to 3.6 m (12 ft) or even 4.2 m (14 ft).

A width of 2.4 m (8 ft) should only be used where: (1) bicycle traffic is expected to be low, even on peak days or during peak hours, (2) pedestrian use of the facility is not expected to be more than occasional, (3) there will be good horizontal and vertical alignment providing safe and frequent passing opportunities, and (4) during normal maintenance activities the path will not be subjected to maintenance vehicle loading conditions that would cause pavement edge damage.

The AASHTO *Guide* also recommends that a graded area 0.9 m (3 ft) or wider be maintained adjacent to both sides of the pavement to provide clearance from trees, poles, walls, fences, guardrails, or other lateral obstructions. The minimum width of such an area should not be less than 0.6 m (2 ft). Where shared use paths are adjacent to canals, ditches, or slopes steeper than 1:3, a separation greater than 0.9 (3 ft) should be considered. In addition, a physical barrier, such as shrubbery, railing, or chain link fence, may need to be provided depending on the depth of drop-off and condition

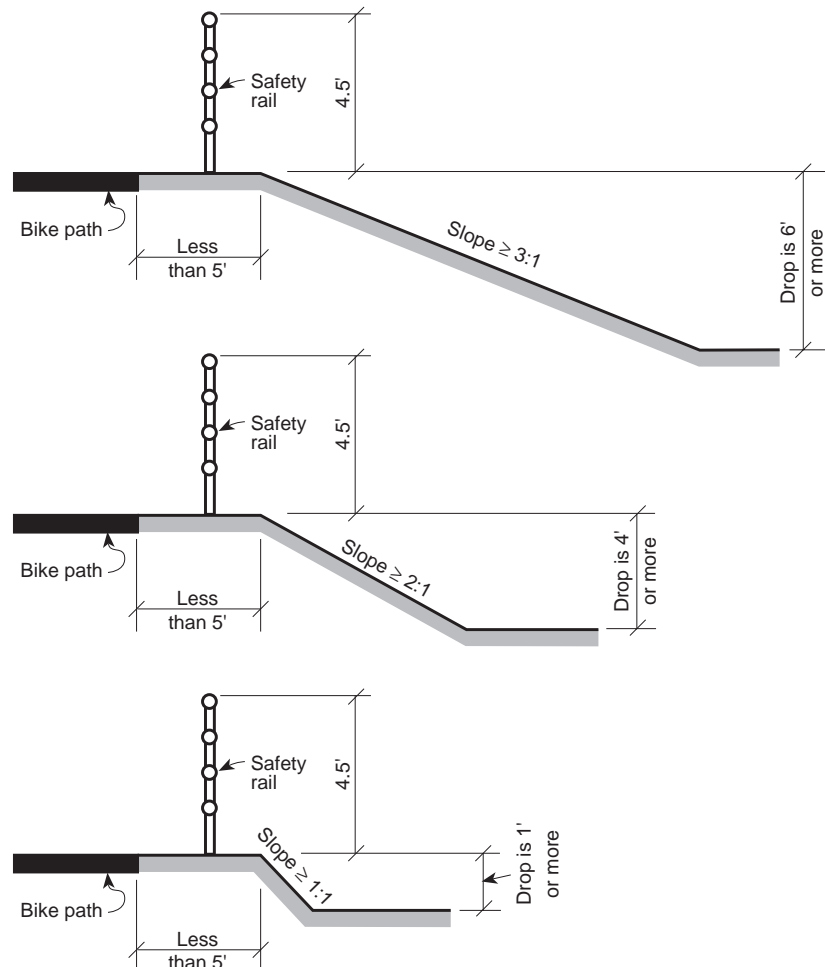

Figure 5.1  
Safety rails

Source: North Carolina Bicycle  
Facilities Planning and Design  
Guidelines

at the bottom. The diagram on the preceding page, taken from the North Carolina Bicycle Facilities Planning and Design Guidelines, illustrates this point.

Another topic of concern to designers involves intersection design; that is, the design of intersections between trails and roadways. As a general principle, it is best if a trail intersects a relatively low-volume roadway, particularly if it can do so at a good location (adequate sight distance, etc.). Some trails, by contrast, intersect roadways at blind curves or in the middle of already-complex intersections. For example, one trail in the Northwest cuts across a signalized “T” intersection on the diagonal with no separate phase for this unusual movement. This intersection is adjacent to a major interstate highway and serves as the entrance to an outlet store shopping mall. In general, it is best to keep trail crossings away from such complex situations. Proper choice of a trail corridor can be the first step in providing safe intersections.

Once a proper intersection site is chosen, good design can help mitigate any remaining hazards. Basic traffic controls (e.g., stop signs and warning signs), combined with judicious clearing of sight lines and adequate overhead lighting is often all that is needed.

One of the most common concerns relates to motor vehicle use of trails. As a result, much attention is given to designing “car-proof” intersections. In some cases, designers have also attempted to keep motorcycles off the trail through the use of special barriers and mazes. Yet, it is important to remember that barriers and the like can often prove hazardous to the bicyclists and others such as those in wheelchairs for whom the trail is intended. In addition, the variety of users—from very young children on their first two-wheelers to parents pulling their children in bicycle trailers to elderly adults on full-sized 1-m- (3-ft-) wide tricycles—warrants care when using barriers of any kind.

Several more appropriate approaches are used in cities with large trail networks that see substantial use. In Madison, Wisconsin, for example, regulatory signs are generally used to keep motorists off trails. If a particular intersection proves troublesome, however, officials then install bright reflective bollards (see below). But they do not do so unless needed.

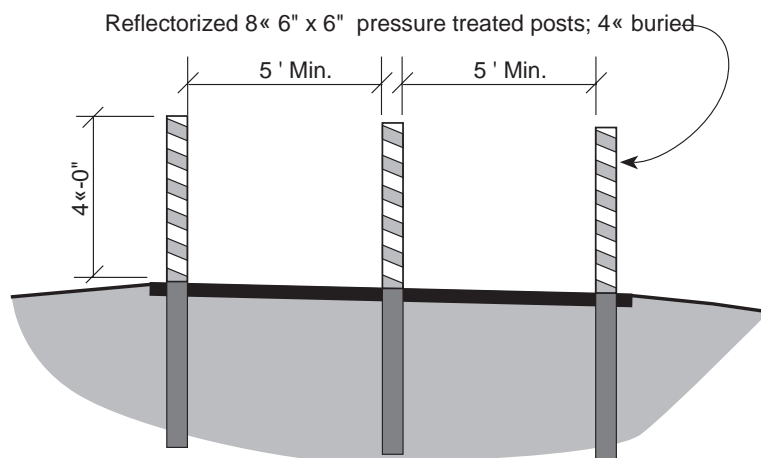

Figure 5.2

*Reflective bollards*

Source: North Carolina Bicycle Facilities Planning and Design Guidelines

In addition to reflectorized posts and overhead lighting, the California Department of Transportation also recommends use of pavement markings to direct bicyclists around bollards. The diagram below shows a typical installation.

Figure 5.3

Pavement markings to direct bicyclists around bollards

Source: North Carolina Bicycle Facilities Planning and Design Guidelines

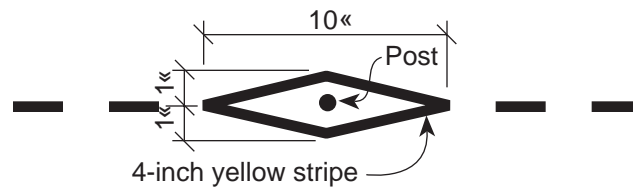

Finally, some agencies prefer to use a more subtle approach to discouraging motor vehicle use. The diagram below, from the North Carolina Bicycle Facilities Planning and Design Guidelines, is based on Ohio's design manual. Similar designs have been used successfully in places like Eugene, Oregon, and Seattle, Washington. The idea is to separate the two directions of trail travel at the intersection and plant low-growing shrubs in the median. While emergency vehicles can still enter the path when needed, most other motorists will find such a design treatment uninviting. See

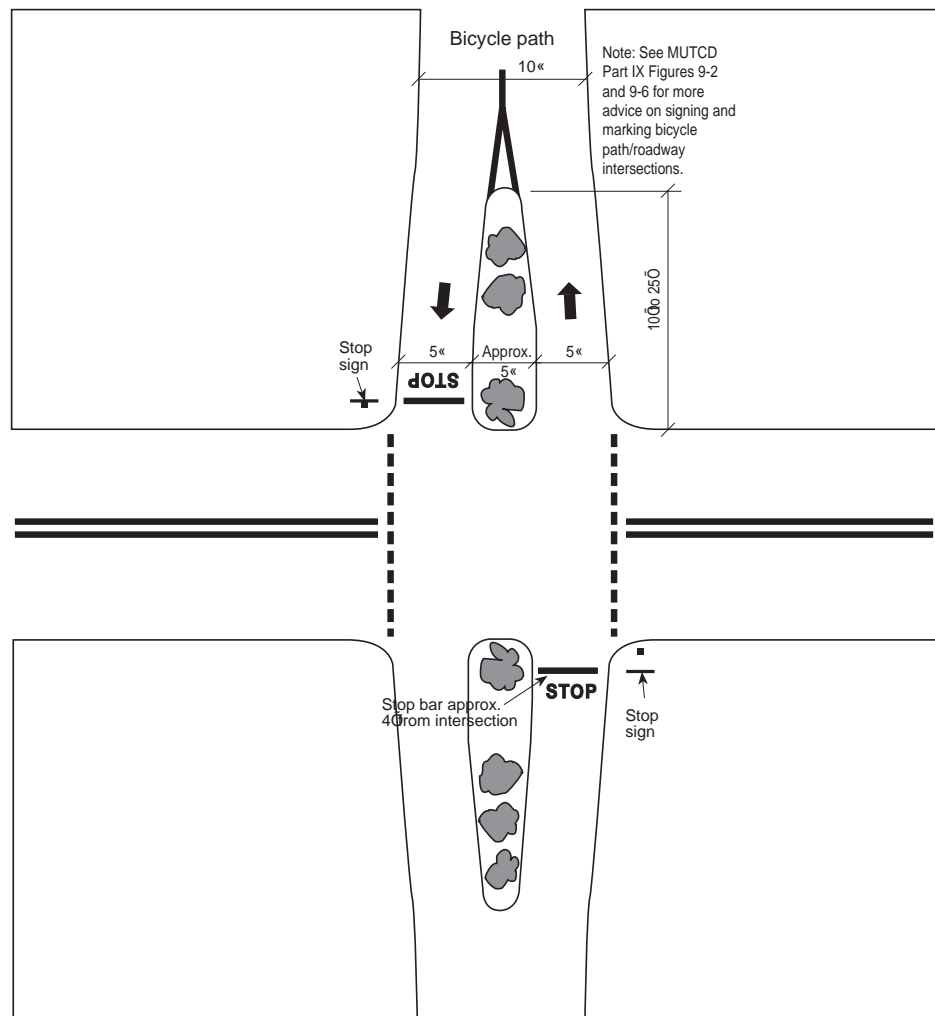

Figure 5.4

Intersection of a trail and a roadway

Source: North Carolina Bicycle Facilities Planning and Design Guidelines

MUTCD Part IX Figures 9-2 and 9-6 for more advice on signing and marking bicycle path/roadway intersections.

## REFERENCES

- Guide for the Development of Bicycle Facilities*, AASHTO, 1998 (pending)
- Trails for the Twenty-First Century*, Rails-to-Trails Conservancy
- Greenways: A Guide to Planning, Design, and Development*, Flink & Searns, 1993
- North Carolina Bicycle Facilities Planning and Design Guidelines*, NCDOT, 1994
- California Highway Design Manual*, CalTrans, 1987
- Ohio Bicycle Facilities Design Guide*, OHDOT, 1988
- Arizona Bicycle Facilities Planning & Design Guidelines*, AZDOT, 1988
- Minnesota Bikeway Design Manual*, MNDOT, 1985
- Maintenance Manual*, AASHTO, 1987



# TRANSIT CONNECTIONS

*Being able to carry bicycles on transit can greatly expand both the range of cycling trips and access to the overall transportation system.*



Photo courtesy of Phoenix Street Transportation Department

## PROBLEM OVERVIEW

**M**ultimodalism is an important feature of transportation planning under the Intermodal Surface Transportation Efficiency Act of 1991 (ISTEA). As stated in the law, “The National Intermodal Transportation System shall consist of all forms of transportation in a unified, interconnected manner, including the transportation systems of the future, to reduce energy consumption and air pollution while promoting economic development and supporting the nation’s preeminent position in international commerce.” (PL 102-240, Sec. 2)

Yet, in many communities, the connections between modes are only just beginning to emerge. One significant gap involves the bicycle and public transit. Far too often, potential transit users who ride their bikes to the nearest bus stop or light rail station will find themselves without a safe place to park. And, with bicycle theft estimated to cost Americans more than \$400 million per year, the lack of safe bicycle parking can be a deterrent to this form of multimodal transportation.

Another aspect of the problem is inadequate or unsafe bicycle access to transit stops and stations. In some instances, transit stations can only be reached via an interstate highway or a high-volume/high-speed arterial street. In such cases, it would be the rare (and brave) bicyclist who would attempt to reach the station by bicycle.

In addition, some transit users would appreciate being able to use their bicycles on both ends of their transit journey. However, that generally means carrying their bikes on board in some fashion and this is often forbidden or discouraged, or is inconvenient for bicyclists and for other transit users.

## SOLUTION OVERVIEW

Transit and bicycling can, under the right conditions, complement each other very well. A transit system can expand a bicyclist's access to the overall transportation system by bridging great distances and by carrying bicyclists over serious barriers. Most studies suggest that the average bicycle trip is approximately 3.2 m (2 mi) in length. At an average speed of 12.9 km/h (8 mi/h), that trip would take 15 minutes. However, by riding to a transit stop, a bicyclist can combine that 3.2-km (2-mi)/15 minute bicycle trip with, for example, a 16-km (10-mi) bus or light rail trip and reach destinations 19.3 km (12 mi) away with the same level of effort.

The transit system can, itself, benefit from encouraging multimodal bicycle-bus trips as well. Since bicyclists typically travel between three and five times as fast as pedestrians, in the amount of time it takes a pedestrian to walk 0.4 km (0.25 mi) to a bus stop, a bicyclist can easily ride a mile or more to the same destination. And the bicyclist will use less energy in the process. This simple fact means that the transit system's capture area can expand dramatically, reaching potential users who would be very unlikely to walk long distances to the bus stop.

There are three primary services that transit operators and transportation agencies can provide to improve access for bicycling customers: 1) secure parking at key transit stops, 2) safe and convenient connections to transit stops, and 3) the means to conveniently carry bikes on the system. These options are discussed in more detail below.

## OBJECTIVES

To develop a strong connection between transit systems and bicycle use in order to encourage the use of both modes:

- By providing adequate levels of secure bicycle parking at key transit nodes.
- By providing adequate bicycle access to transit connections.
- By providing for bicycle transport on bus and rail systems.

## IMPLEMENTATION STRATEGIES

Implementing “bicycle-friendly” changes to the transit system involves working on three fronts simultaneously: 1) establish a bicycle parking program to systematically identify transit-related parking needs—current and potential—and take advantage of opportunities for installation; 2) identify barriers and develop necessary improvements such as connecting paths, low-stress bicycling streets, or modifications to arterial streets to allow bicyclists to reach the stations conveniently; and 3) develop policies, supported by the necessary practices and related hardware, to allow bicyclists to take their bikes on the transit system in a safe and convenient manner.

## SUBTASKS

### 1. Research current bicycle-related policies and practices

Many transit systems throughout the country have policies and practices that deal—either explicitly or implicitly—with bicyclists. These should be identified and considered for modification as part of a bicycle-encouragement program.

### 2. Create “bicycle-friendly” policies and practices

Working closely with staff from relevant departments, modify existing policy guidelines and routine practices to encourage a stronger bicycle/transit connection. Suggested changes may include allowing bicycles on buses at certain times or under certain conditions; for a rail-type system, changes may include creating a permit system to allow bicyclists to bring their bikes on-board during certain hours, on certain trains, or in certain cars of the trains. Another change might be to add bicycle parking to the checklist of required items for new transit stops. Or they may include encouraging bus operators to undergo a short course in “dealing with bikes” while driving.

### 3. Identify locations with access problems

Assess the ease with which bicyclists can reach key transit system locations. Using a map of the network, mark problem areas and major barriers. For example, a primary bus stop may be located at mid-block along a busy eight-lane arterial street. For many bicyclists, this would count as an inaccessible location. Moving the stop to a site near an intersection may enhance bicycle access—especially if that street’s crossing is improved with bicycle-sensitive traffic signals and similar “bicycle-friendly” features. As another example, consider a rail transit station located in the middle of an interstate highway. In order for bicyclists to reach this site, some sort of special access (e.g., a bike/pedestrian overpass) may be needed.

### 4. Identify locations that will benefit from the addition of bicycle parking

Using a map of the network, identify locations that will most benefit from the addition of bicycle parking. For example, all transit stations near residential areas or work centers should include bicycle parking. Major bus stops that are near residential areas and serve several key bus routes should be considered as well.

### 5. Prioritize locations and propose solutions

Some sites will hold more promise than others, in terms of encouraging a stronger bicycle/transit connection. For instance, a park-and-ride lot located in the middle of nowhere would benefit little from the provision of bicycle parking. Sites near residential areas, on the other hand, would most likely be viable locations.

### 6. Implement the system

To implement a system of bicycle improvements for a transit system, determine an annual budget for the program and create a workplan based on the prioritized list of locations and projects. Some aspects of the work



must be done by street or road departments while others can be accomplished by the transit agency.

## 7. Evaluate the results

Keep track of the results of the program, as projects are implemented. Measure bicycle use before installation and after; in subsequent years, it is helpful to do additional bicycle counts to determine changes in use. Survey users regarding their satisfaction with the improvements and their ideas for future work.

## RESOURCE REQUIREMENTS

The resources required for this program can be broken down into several categories. First, road improvements needed to improve access may involve new pavement, restriping, modifying intersections or, in some cases, installation of bicycle grade separations (e.g., overpasses or underpasses). Second, resources required to implement a bicycle parking program consist of racks and lockers and are readily available from a variety of commercial vendors. Third, allowing bicyclists to take their bikes on a rail-type transit system will require administrative support and possible modifications to entrance gates and other physical features of station architecture. Allowing bikes on buses will primarily require special racks, which are available from several vendors.

## SCHEDULE

**Short-term:** Short-term projects include small-scale construction projects, bike-on-bus projects, and simple bicycle parking provisions.

**Long-term:** Long-term projects include more complex construction projects providing access to stations, possibly implementation of new policies for allowing bicycles on trains, and projects that will be completed as incidental parts of major transportation improvements.

## SPECIFICATIONS

### Bicycle parking

Considerations for bicycle parking are similar to those discussed in the Bicycle Parking section of this report. Long-term parking and high security lockers should be considered more seriously, however, since most transit users will likely leave their bicycles for extended periods. Parking should be located at a highly visible site that is, at the same time, out of the direct flow of pedestrian traffic.

### Bike-bus racks

The most popular bike-bus racks carry two bicycles. They are fold-up devices that attach to a bracket on the front of a bus.

### Bicycle connections to stations

On-street connections should allow bicyclists to use “bicycle-friendly” streets (e.g., low-stress collectors or arterial streets that have been modified for bicycling) to reach transit stations. Actual physical improvements should be designed based on advice found in other sections of this manual, as well as the AASHTO *Guide*.

## Bicycles-on-transit policies

Policies that allow bicycles on transit trains should be developed after serious consideration of both the options and local needs. A good source of specific approaches is the report entitled “Linking Bicycle/Pedestrian Facilities with Transit” (Michael Replogle, 1992).

## REFERENCES

*National Bicycling & Walking Study Case Study 9: Linking Bicycle/ Pedestrian Facilities with Transit*, FHWA, 1992

“Bikes on Buses in Pierce County, Washington,” Marie Keister, *Bicycle Forum*, 1992

“Bus Meets Bike in Eureka, California,” John Gill, *Bicycle Forum*, 1987



# ROADWAY BRIDGE MODIFICATIONS

*Some bridges are “pinch points” for cyclists. Such structures, if not improved for cyclists, can reduce roadway width or inhibit access.*



## PROBLEM STATEMENT

Bridges, almost by definition, are squeeze points: places where traffic must come together to cross an obstacle. Often, that obstacle is a body of water, although it could easily be something else—for example, a railroad yard, or a freeway. For bicyclists, the problem with bridges is twofold: first, since bridges are often less common than are nearby roads, route options may be limited to high-volume roadways; second, since bridges are expensive to build, extra space is generally limited.

In many cases bicyclists are, therefore, funneled on to narrow high-volume roads. And, while some bicyclists can handle the situation, many cannot. As a result, the presence of bridges or overpasses in key corridors can often reduce the amount of bicycling in a community.

## SOLUTION STATEMENT

There are two primary solutions to this problem. First, in some cases it may be possible to build a bicycle bridge, overpass, or underpass connecting low-volume roadways or segments of a trail network. This approach, discussed in another section, is particularly useful for providing new access, especially if it results in a significant short cut.

The other alternative is to modify roadway bridges to provide for bicyclists. In many cases, it is important to make such modifications whether or not there are nearby opportunities for trail bridges or other independent structures. Often, for example, a modified roadway bridge will better serve utilitarian needs like shopping and commuting to work or school. Such modifications may involve adding width to the traveled way, altering connecting ramps at the bridge ends, and making the deck more suitable for bicycle use.

In general, using both solutions in tandem—if feasible—may help better serve a wide variety of bicyclists. Youngsters and less-experienced adult riders often feel more comfortable on a trail bridge, and skilled adults may find a well-placed structure cuts off a significant part of their journeys. On the other hand, some trips (e.g., commuting to work) are often best made on the through routes and riders of all skill levels may need to make such trips.

## IMPLEMENTATION STRATEGIES

In some instances, it is possible to modify an existing bridge for the sole purpose of improving bicycle access. In cases where the modifications are minor, this can easily be done; some types of bridge deck modifications (e.g., adding expansion joint covers or restriping the existing deck to create bike lanes or wide curb lanes) are relatively small-scale projects that can be easily accomplished in this fashion. And, yet, they can significantly improve conditions for bicyclists. However, if major construction is needed, the most likely approach is to include bicycle considerations when the bridge is replaced or extensively modified. In some special circumstances, an independent project to add major improvements for bicyclists could be considered, particularly if current conditions are especially hazardous and there is a significant potential for bicycling crashes, injuries, and fatalities.

In general, decades go by between major projects at a particular bridge location. The recommended approach, therefore, is to determine the schedule for improvements and suggest appropriate bicycle accommodations for each project. The earlier in a project's history that bicycle elements are considered, the more likely they are to be implemented. With some bridge projects—for example, those under construction or in the middle of the bid process—only small modifications may be possible. However, if a bridge project is years away from completion, it is very feasible to include serious modifications to accommodate bicyclists.

Ultimately, it may be best to modify bridge design standards to include bicycle accommodations. In this way, such improvements will not be seen as exceptions but, rather, as the rule. New bridges should include wide shoulders as a matter of course. Following the recommendations of the Policy on Geometric Design of Highways and Streets (AASHTO; 1990) will result in shoulders at least 1.8 m (6 ft) wide, an adequate width for bicycle travel.

## OBJECTIVES

To accommodate bicycle traffic on roadway bridges:

- By including bicycle-friendly features in new bridge construction and reconstruction projects.
- By independently adding bicycle accommodations where sufficient need has been identified.

- By adopting design standards for bridges that include reasonably wide and smoothly paved shoulders.

## RESOURCE REQUIREMENTS

For the most part, providing bicycle accommodations on bridges is simply a matter of following commonly understood engineering practice and budgeting adequate funding for the extra width and other needs.

## SUBTASKS

### 1. Review and, if necessary, modify design standards for roadway bridges

Identify typical cross sections used by local public work agencies in rural and urban bridge work. Compare the requirements with the bicycle-safe approaches described in the Specifications section below. Unsuitable designs should be replaced with better specifications.

### 2. Survey all local roadway bridges

Through field inspections, determine bridge deck widths, number of lanes, widths of outside lanes, surface quality, presence (or absence) of hazards in areas most likely to be used by bicyclists, and the situations at bridge ends and ramps. Determine which locations are in need of improvement.

### 3. Identify high-priority locations for major projects

While all hazardous locations should eventually be improved, the best places to start are on popular bicycling routes, connections between important destinations (e.g., schools and housing developments), bridges that are scheduled for improvement, bridges that can be easily modified, and locations where bicycle safety problems have been previously identified.

### 4. Develop appropriate solutions to major problems

Draft proposals for bicycle improvements and work to include them in descriptions for all relevant bridge construction and reconstruction projects.

### 5. Develop appropriate solutions to minor problems

Draft proposals for simple bicycle improvements and work to include them in routine bridge maintenance and spot improvement programs.

### 6. Evaluate results

On at least an annual basis, determine what progress has been made toward the goal of providing bicycle improvements on roadway bridges. Consider the number of structures improved, the importance of those projects to local bicyclists, the status of proposed changes to the current design standards, and the proportion of new construction and reconstruction projects that include bicycle improvements.

## SCHEDULE

For the most part, this program involves adding bicycle improvements as “incidental” features of major bridge construction projects. For this reason,

the schedules for those features should be integrated into the overall schedules of the projects involved.

## SPECIFICATIONS

### Paved width

Providing adequate width on roadway bridges can be accomplished in several ways. First, adding striped bicycle lanes to each side can give bicyclists a greater sense of comfort and can provide continuity to a bicycle lane system. Lanes should be a minimum of 1.5 m (5 ft) in width. Greater width should be considered where high curbs or railings are immediately adjacent to the roadway or where traffic speeds and/or truck volumes are high.

Similarly, on highway bridges, extending the paved shoulder's width across the bridge can provide bicyclists with continuity of service. AASHTO's *A Policy on Geometric Design of Highways and Streets* (1994), also referred to as the Green Book, states "The minimum clear width for all new bridges on streets with curbed approaches should be the same as the curb-to-curb width of the approaches. For streets with shoulders and no curbs, the clear roadway width preferably should be the same as the approach roadway width..." Depending on factors like the prevalence of crosswinds, typical motorist speeds and volumes, and the percentage of truck traffic, shoulder width required could vary between 1.8 and 3 m (6 ft and 10 ft).

In some cases, simply providing a widened outside travel lane can adequately accommodate bicyclists. This would be most suitable on lower speed roadways with no complicating factors. In such cases, the width of the outside travel lane should be at least 4.3 m (14 ft). Extra width should be provided if edge conditions justify.

On some bridges, particularly those in rural and semi-rural areas, the deck may be wide enough to allow one striped shoulder or wide outside lane but not two. At the same time, there may be a sidewalk on one side of the structure. If pedestrian volumes allow, it may be possible to install ramps or curb cuts leading to the sidewalk for one direction of bicycle travel and restripe the traffic lanes to give a striped shoulder or wide outside lane on the other side (see below).

Figure 7.1

*Adapting a narrow bridge to accommodate bicycles where pedestrian volumes are low*

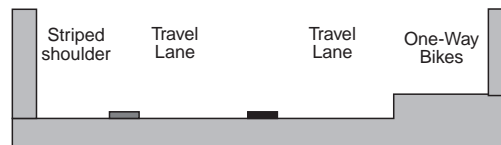

### Surface conditions

To encourage bicycle use, the surface of the bridge should be smooth, particularly in those areas likely to receive bicycle traffic. Special attention should be paid to expansion joints, longitudinal gaps, longitudinally grooved pavement, and honeycomb steel decking.

In the case of uneven expansion joints, a non-skid steel cover with

beveled edges can be mounted over the top and attached to one side of the joint. Similarly, longitudinal gaps can be covered with a non-skid surface or filled with a weatherproof sealant.

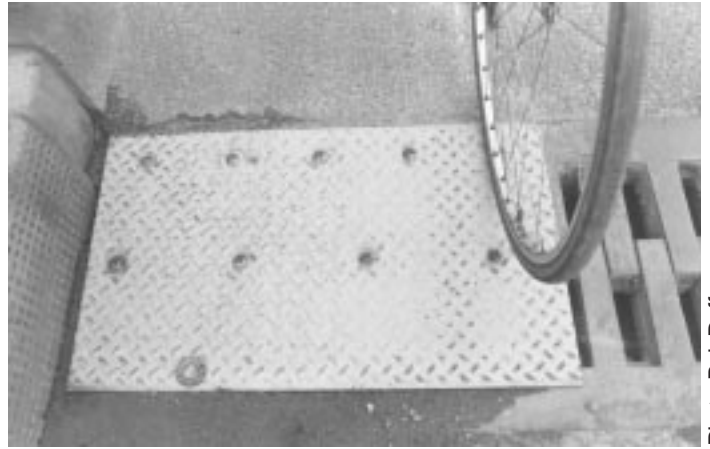

Photo: Bob Duffy

Grooved pavement surfaces should be discontinued in the area near the right edge of the travelled way. A smooth surface should be provided for at least 1.2 m (4 ft) of width. If the bridge is a popular bicycling route, if it has a high curb or adjacent railing, or if it is on a high-speed route, the width of the smooth surface should be increased.

A steel honeycomb bridge decking can lead to control difficulties for bicyclists, particularly if the riders are inexperienced or weather conditions are inclement.

Filling the voids with light-weight concrete is one solution used to successfully solve the problem. Such modifications, however, should only be made with competent engineering advice.

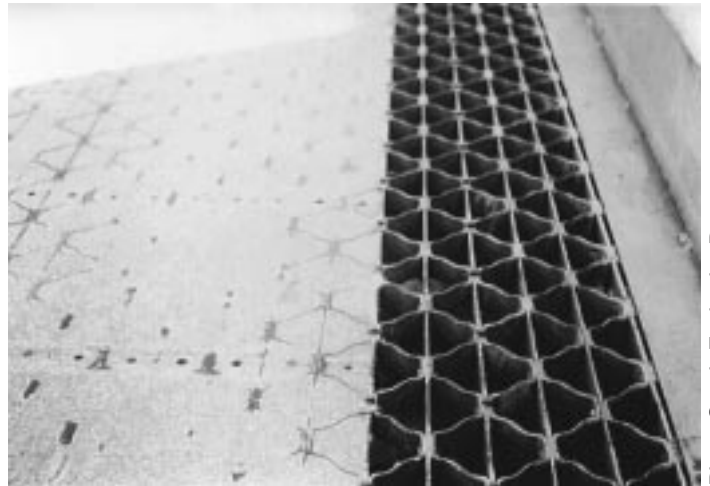

Photo: Seattle Engineering Dept.

## Bridge approaches

For bicyclists to safely use a bridge, they must be able to reach it. Therefore, approaches should be designed with bicyclists' needs in mind. The bicyclists' expected path should not be crossed by high-speed merging ramps if at all possible. In such cases—especially if traffic volumes or speeds are high—it may be best to encourage bicyclists to leave the roadway at the first possible exit.



## Bridge railings

Railings adjacent to the area occupied by bicyclists should be high enough to prevent pitch-over if a bicyclist loses control. A height of 1.4 m (4.5 ft) is necessary for this purpose. AASHTO's *Standard Specifications for Highway Bridges* (1989) offers guidance on the details (see diagram below).

Figure 7.2  
Bridge railings  
for combined  
motor vehicle  
and bicycle  
bridges  
after *Standard  
Specifications for  
Highway Bridges*  
(AASHTO, 1989)

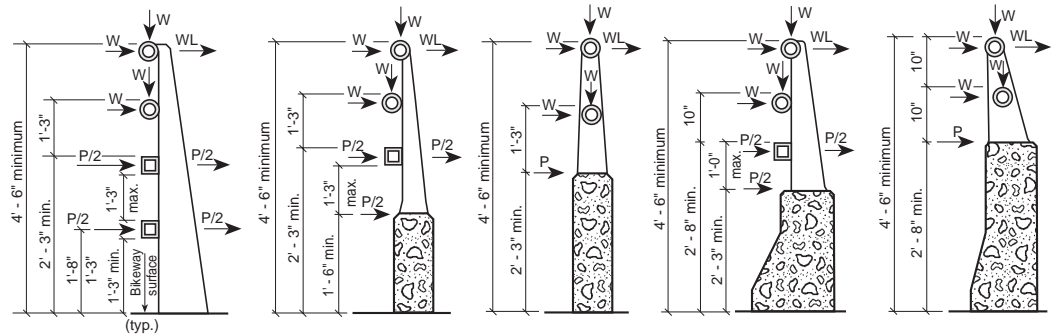

## Debris

Debris near the right edge of a bridge deck can reduce the available width for bicycling and can provide hazards for bicyclists to hit. Routine maintenance should, therefore, include cleaning of this area and the removal of objects like car parts, tires, and cans and bottles.

## REFERENCES

- “Bridging Bremerton’s Expansion Joints,” Steve Davis, *Bicycle Forum*, 1981
- Guide for the Development of Bicycle Facilities*, AASHTO, 1990
- North Carolina Bicycle Facilities Planning and Design Guidelines*, NCDOT, 1994
- Standard Specifications for Highway Bridges*, AASHTO, 1989

# RAILROAD CROSSINGS

*At-grade railroad crossings can pose a serious hazard for cyclists. A diagonal crossing can entrap and divert a bicycle's front wheel, causing the cyclist to fall.*



Photo courtesy Seattle Bicycle/Pedestrian Program

## PROBLEM STATEMENT

**A**t-grade railroad crossings cause numerous problems for bicyclists, the least common of which involves actually being hit by a train. Generally, it is the track itself or the surrounding railbed that causes bicyclists the most grief, especially when combined with the threat of closely passing motor vehicle traffic. Crossings on high-speed/high-volume roads with narrow outside travel lanes are probably the worst examples, but the problems exist on many otherwise rideable bicycling routes.

On diagonal railroad crossings, the gap next to and on the inside of the rail (called the “flangeway”) can trap a bike’s front wheel causing it to divert. The result is a surprisingly quick fall for the bicyclist. This problem is most serious when the track crosses at an angle less than 45 degrees to the direction of travel. The more shallow the angle, the more hazardous a crossing is for bicyclists. Wet weather exacerbates the situation, making the tracks even more slippery than normal.

In addition to diagonal track problems, it is important to remember that virtually all railroad crossings take a continual and significant beating

from both motor vehicle traffic and train traffic. As a result, crossings may be very rough and uneven. Timbers may break up or shift; asphalt may crumble, mound into large bumps, or be filled with potholes and cracks.

As a result, crossings often require frequent maintenance and can cause bicyclists either wheel damage or serious falls, or both.

## SOLUTION STATEMENT

### Diagonal railroad crossings

There are two primary solution approaches to this problem: 1) provide a way for bicyclists to approach the track at a wider angle; and 2) fill the flangeway with a rubberized material.

The first approach can best be accomplished by flaring out the roadway (see diagram in “Specifications” section below). In this way, the bicyclist can cross at a better angle without swerving into the path of passing motor traffic.

The second approach, installing a flangeway filler adjacent to the inside edge of the track, works only on very-low-speed rail lines (e.g., in an industrial yard). Since a passing train’s wheels must compress the dense fill material, the train must be moving slowly. The wheels of a fast-moving train will not compress the fill and will, as a result, derail. However, in the proper setting, flangeway fill can solve a serious bicycle safety problem very well.

### Rough railroad crossings

Frequent maintenance, therefore, is essential to solving this problem. However, the best solution is to replace a defective crossing with either a non-slippery concrete crossing or one of the rubberized installations. The latter are not simply rubber pads placed over existing crossings. They typically involve replacement of the trackbed with a concrete slab and extensive construction work. While the resulting crossing may cost significantly more to install than the less expensive timber or asphalt crossings, they generally save money in long-term maintenance.

Some new rubberized crossing systems involve less extensive construction than the full-fledged approach described above. However, their long-term benefits for bicyclists are, at this time, unknown.

## IMPLEMENTATION STRATEGIES

Specific railroad crossing problems vary, depending on the crossing angle, the type of roadway surface, the number of lanes, and the type of rail and roadway traffic. However, the basic strategy is to identify the type of hazard (diagonal vs. rough), the degree of hazard (e.g., a crossing at 45 degrees vs. a crossing at 20 degrees), the importance of the crossing (e.g., a popular bike route vs. an industrial area with little bike traffic), and the type of solution that is most suitable (e.g., flangeway filler vs. pavement flaring). While numerous small problems may be solved in a fiscal year through routine maintenance functions, some of the problems may be large enough to require significant planning, engineering, as well as allocation of time and

money. These latter projects, once identified, should be included in the Transportation Improvement Program and should be identified by system (e.g., “urban,” “national highway system,” etc.) to determine potential sources of funding.

## OBJECTIVES

To eliminate hazardous railroad crossings:

- By identifying all local at-grade railroad crossings.
- By determining which are hazardous for bicyclists.
- By prioritizing those hazardous crossings identified.
- By determining which approaches will work with which crossings.
- By including a reasonable number of crossings as projects in the TIP.
- By evaluating progress on a regular basis.

## RESOURCE REQUIREMENTS

Depending on the problem identified and the solution chosen, the resources necessary for a particular crossing may vary from a few warning signs to a full concrete or rubberized crossing. The first option could probably be installed for less than \$200, depending on departmental labor rates. The latter could easily cost \$100,000, depending on the roadway width and other geometric and traffic considerations.

## SUBTASKS

### 1. Identify crossings

Using a current, accurate, and detailed local road map, highlight all instances where a roadway crosses a railroad track or set of tracks. In addition, identify the responsible agencies or companies for all crossings shown on the map.

### 2. Determine hazards

Use the map described above to locate crossings that are either diagonal (45 degrees or less) or rough. If the map is sufficiently accurate, diagonal crossings may be measured and identified in the office. However, the roughness and flangeway opening of the crossing are best determined by riding across it on a bicycle.

### 3. Prioritize hazardous crossings

Set priorities on improving the hazardous railroad crossings identified in the previous step. There are four primary factors to consider when prioritizing hazardous railroad crossings: 1) public desires, 2) the degree of hazard, 3) the likely importance of the route, and 4) the potential for a solution.

Through public involvement procedures, identify those crossings that are of most concern to the bicycling public. This may be done through public meetings, surveys, or media efforts. However, these processes may fail to identify some critically important projects. This is particularly true if the publics reached do not include groups like school children or casual riders.

Next, consider the actual degree of hazard, taking into account the angle

of the crossing, its roughness, and flangeway opening, as well the combined effects of all three factors (if present). In addition, consider whether the crossing is near a potential bicycle traffic generator (e.g., a school, neighborhood commercial area, or residential area). Further consider whether it is on either a popular bicycling route or is on the only route through a particular area.

Finally, consider the potential for a solution. Factors include how expensive the solution may be, the cooperativeness of the railroad, and whether the crossing is scheduled for improvement and whether there is sufficient public support, especially in the case of a potentially expensive project.

#### 4. Determine approaches

With diagonal crossings, determine whether the track is a low-speed line, where a flangeway fill may work. If it is not, consider the potential for widening the paved roadway surface to give bicyclists room to cross at a wider angle. If neither of these is a possibility, consider warning signs and/or pavement markings to warn bicyclists about the problem.

With rough crossings, determine the potential for a rubberized crossing installation across the entire roadway surface. If costs are too high and benefits for other road users are likely to be insignificant, look at the possibility of installing two rubberized crossing sections in the outside lane, bike lane, or paved shoulder of each side of the roadway. The key is to install the sections where bicyclists will be riding. If it is financially impossible to improve a hazardous crossing in the near future, the possibility of providing warning signs should be considered.

#### 5. Select projects

On the basis of the priorities determined above and the type of work required, set a schedule for inclusion of the projects in the Transportation Improvement Program.

#### 6. Evaluate results

On at least an annual basis, determine what progress has been made toward the goal of making crossings bicycle-safe. Consider the number of crossings improved, the extent to which the most critical have been dealt with, and whether new crossing problems have arisen.

## SCHEDULE

In the short term, it is relatively easy to identify hazardous crossings and install bicycle-related warning signs or markings. Paving aprons for bicyclists to approach diagonal crossings at a wider angle will take longer, depending on factors like shoulder condition and available space. Replacing crossings with rubberized installations will take the longest time of all, depending on budgeting considerations, as well as the cooperation of the railroad involved.

## SPECIFICATIONS

### Diagonal railroad crossings

The first approach to dealing with a diagonal railroad crossing is to flare the roadway, as shown in the diagram at right. In this way, the bicyclist can cross at a wider angle without swerving into the path of passing motor traffic. The width of the flare and its particular angles depend largely on the angle at which the track crosses the road. Tracks that cross at very shallow angles require bicyclists to turn to a trajectory that is far from the direction of the roadway in order to cross safely. For this reason, such angled crossings will require the greatest width.

Figure 8.1

*Roadway flare allows wider angle crossing*

Source: adapted from Lubbock Metropolitan Area Comprehensive Plan, Bicycle Federation of America

On the other hand, tracks that cross the road at 45 or more degrees to the direction of travel will require relatively little extra width to allow bicyclists to cross at a wider angle.

The second approach, installing a flangeway fill, works only on very low speed rail lines. Since a passing train's wheels must compress the dense fill material, the train must be moving slowly. The wheels of a fast-moving train will not compress the fill and will, as a result, derail. However, in the proper setting flangeway fill can solve a serious bicycle safety problem very well. And even on higher speed rail lines, reducing the flangeway width to a minimum is a needed improvement.

If a crossing is particularly hazardous and no physical improvement is possible in the near term, installation of warning signs may be warranted.

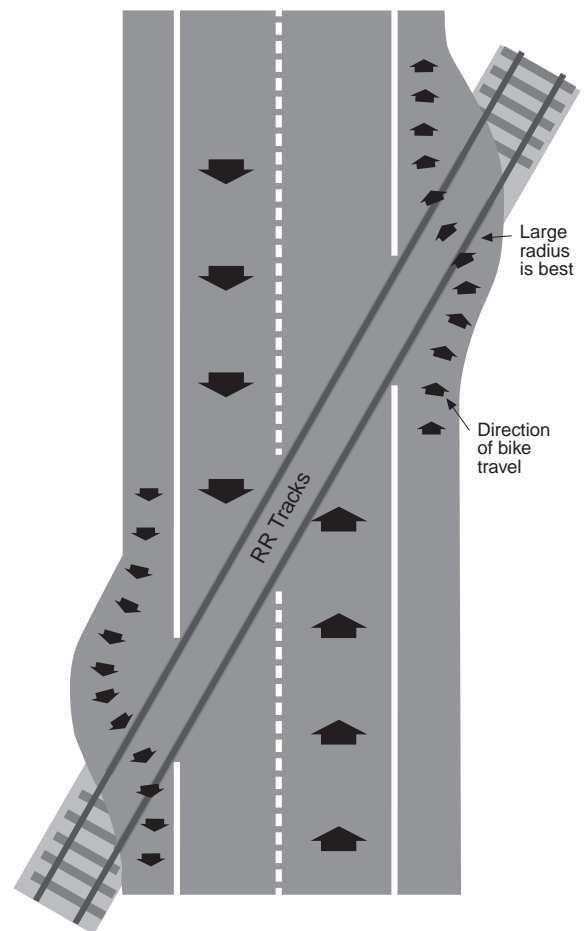

*Roadway flare allows wider angle crossing*

Figure 8.2

*Flangeway filler strip applied to the inside flangeway to the rail*

Source: adapted from Lubbock Metropolitan Area Comprehensive Plan, Bicycle Federation of America

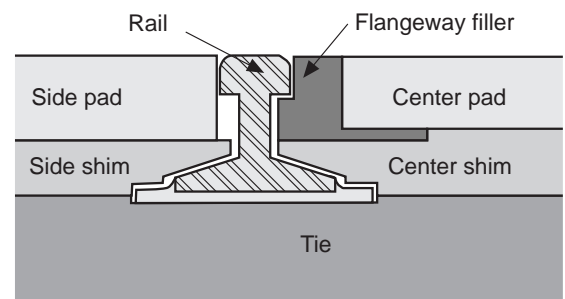

*Flangeway filler strip applied to the inside flangeway to the rail*

Currently, there are no standard signs for this purpose. The development of a standard warning sign would be helpful. In the meanwhile, however, several communities have experimented with different options. The sign shown at right is one possibility for such an installation.

Figure 8.3

Source: adapted from Lubbock Metropolitan Area Comprehensive Plan, Bicycle Federation of America

A possible warning sign for use at diagonal railroad crossings



### Rough railroad crossings

The best solution is to replace a defective crossing with one of the rubberized or concrete installations. While these may cost significantly more to install than the less expensive timber or asphalt crossings, they generally save money in long-term maintenance. A number of companies make such crossing systems.

Figure 8.4

Source: adapted from Lubbock Metropolitan Area Comprehensive Plan, Bicycle Federation of America

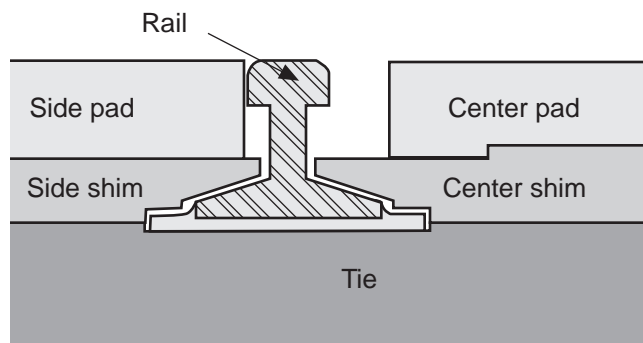

Rubberized railroad crossing, a more durable long-term solution than timber crossings.

## REFERENCES

*Guide for the Development of Bicycle Facilities*, AASHTO, 1998 (pending)  
*North Carolina Bicycle Facilities Planning and Design Guidelines*, NCDOT, 1994

# TRAFFIC SIGNALS



*Traffic signals can be designed or modified to detect and respond to bicycles.*

## PROBLEM OVERVIEW

There are four primary bicycle-related problems with traffic signal installations. First, many demand-actuated signal systems—those that change when traffic is detected—were designed and installed without attention to their effects on bicyclists. As a result, bicyclists may find it impossible to get a green light.

Second, programmable signal heads may be oriented in such a way as to make it impossible for most bicyclists to tell if they are green or red. This can happen when such signal heads are checked only in the middle of the travel lane and are set up exclusively for that location.

Third, minimum green time may be inadequate for bicyclists to clear the intersection. As a result, bicyclists can be caught in an intersection during the change from green to red. A national study (Cross, Fisher, 1977) found that approximately 3 percent of reported non-fatal car/bike crashes involved a bicyclist caught in a signalized intersection during a phase change. These crashes typically happened while the bicyclist attempted to cross a multi-lane road.



And fourth, synchronized traffic signal systems may be set to accommodate typical or desirable motor vehicle speeds but may not work well for most bicyclists. Bicyclists traveling at significantly lower speeds than motor vehicles may find themselves stopped by successive red lights while motorists are able to match their speeds to the signal timing and, as a result, meet only green lights.

## SOLUTION OVERVIEW

### Demand-Actuated Signals

Numerous advances have been made in detecting bicyclists at demand-actuated signals. There are four primary approaches currently in use: 1) installing more bicycle-sensitive loop systems (e.g., quadrupole, diagonal quadrupole, or quadracircle loops); 2) marking current loops that do detect bikes; 3) adjusting systems that do not detect bikes; 4) converting to new technology (e.g., infrared or video systems); and, finally, 5) converting demand-actuated signals to pre-timed signals.

### Programmed Visibility Heads

Programmed visibility heads require a simple adjustment in order to be visible from typical bicyclist locations. Signal crews should check the signal's visibility from the right edge of the roadway and adjust accordingly.

### Signal Timing

Signal timing should be set according to the guidance provided on page 71.

### Signal Synchronization

Where bicycle use is high, signal timing should take into account the convenience of bicyclists. For example, signals in downtown Portland are timed for speeds of 12 to 16 mi/h, allowing bicyclists to ride with the rest of traffic (Oregon Bicycle Plan, 1995). Interestingly, synchronizing signals to a relatively slow speed has been suggested as a traffic calming measure applicable under certain urban conditions.

## OBJECTIVES

1. To ensure that existing traffic signal installations work properly for bicyclists:

- By testing and, if necessary, modifying demand-actuated signals to detect bicycles.
- By testing and, if necessary, adjusting programmed visibility heads to be visible from the most common bicycle positions (e.g., the right side of the roadway).
- By testing and, if necessary, adjusting the green and yellow phases of all signals to accommodate bicyclist speeds.
- By synchronizing traffic signals to work for both motor vehicles and bicycles, to the extent possible.

2. To ensure that new traffic signal installations work properly and safely for bicyclists:
  - By requiring bicycle-sensitive detectors in all new installations.
  - By requiring all new programmed visibility heads to be visible from the most common bicycle positions (e.g., the right side of the roadway).
  - By requiring all new installations to accommodate common bicyclist speeds—both in terms of individual signal clearance intervals and, if possible, overall system synchronization.

## RESOURCE REQUIREMENTS

Most signal improvements can and should be done on a routine basis using funds set aside for signal maintenance work. However, some may require more serious attention; in such cases, a special fund that pays for the elimination of such problems can be a good approach. Setting aside a specific amount of money per year to make bicycle-related improvements to systems can help ensure the gradual elimination of bicycle-related traffic signal problems.

## IMPLEMENTATION STRATEGIES

Two primary implementation strategies suggest themselves for solving these problems. First, slightly altering routine signal maintenance procedures can catch existing problems. Second, using bicycle-friendly design standards and equipment can keep new problems from being created.

## SUBTASKS

### 1. Modify testing and repair procedures

When a signal system receives attention in the field, its reliability and utility for bicyclists should be checked. The three topics of greatest interest are, as mentioned above, the sensitivity of demand-actuated systems, the visibility of programmed visibility heads, and the length of the clearance interval.

Detection devices should be tested to determine their sensitivity for bicyclists. The best way is for one person to test the loop with a bicycle carried specifically for this purpose, while another person adjusts the loop's sensitivity at the controller. In so doing, determine whether the loop can reliably detect bicycles in an appropriate location. If so, mark the location with spots of spray paint and ask the pavement marking crew to place a symbol like that shown in Figure 9.2 on page 70. If not, note the intersection's location and problem for further attention.

Next, determine the necessary length of the clearance interval, based on the chart shown later in this section. If bicyclists are unable to clear the intersection in the available time, adjust to rectify the problem by adding time to the yellow phase or, possibly, adding an all-red phase.

Finally, check any programmed visibility heads for their readability in a normal bicycling location. This location will typically be near the right side of the outside lane. Adjust the signal head if needed.

## 2. Identify and list signals that need further attention

If simple field adjustments, markings, or minor repairs will not solve the problem at an intersection, it should be identified for further attention. Most likely, the problem will be an unresponsive loop detector. List the location, the nature of the problem, and any important parameters (e.g., traffic channelization, the existence of a popular bicycle route, old controller hardware, impending repaving projects, etc.).

## 3. Prioritize the list

Since it is seldom possible to solve all problems at once, it is important to set priorities for signal improvements. Factors to consider include: the seriousness of the crossing situation (i.e., can a bicyclist actually get across the intersection safely?); popularity of the route for bicyclists (is it near popular destinations or does it serve an important need?); presence of reasonable alternative routes; likely cost of the improvement; and planned projects that could include the improvement as an “incidental” feature. These factors should not determine whether an improvement is needed. All signalized intersections should work for bicyclists. Rather, the factors simply help determine which should be fixed first.

## 4. Implement the improvements

Develop a schedule and budget for making the improvements. One option to consider is the creation of a “bicycle signal program” and include it as a single item in the Transportation Improvement Program. By creating such a program, it would be possible to combine a number of small bicycle-related signal improvements into one budget item that could be funded through a variety of transportation funding sources.

## 5. Evaluate the results

On an annual basis, compare the number of intersections improved against the list of candidate intersections. In addition, routinely test improved intersections for sensitivity. Occasionally, frost heave and other such factors can damage a loop detector, making bicycle detection less reliable or impossible.



*Pavement guide lines at signalized intersections can facilitate the movement of left-turning bicyclists.*

## SCHEDULE

**Short term:** Make on-going repairs to existing traffic signal installations.

**Long term:** Ensure that future projects comply with bicycle-friendly standards.

## SPECIFICATIONS

### Bicycle-actuated signals

Appropriate solutions to the problem of unresponsive demand-actuated signals depend on the particular characteristics of the intersection, the type of bicycle facility chosen, and the hardware in place. The following are four common situations and possible solutions for dealing with them.

<i>Type of Route</i>	<i>Existing Loop</i>	<i>Solution Options</i>
Street with bicycle lanes*	• Rectangular in travel lane	<ul style="list-style-type: none"> <li>• Add quadrupole loop in bike lane</li> <li>• Mark sensitive location (if there is one AND IF it is in the bicycle lane)</li> <li>• Change to pre-timed**</li> </ul>
Shared lane street	• Rectangular	<ul style="list-style-type: none"> <li>• Replace with diagonal quadrupole</li> <li>• Mark loop with pavement marking (if it can be adjusted to detect bikes)</li> <li>• Add small loop in proper location and mark with pavement marking</li> <li>• Change to pre-timed*</li> </ul>
Street w/right-turn lane**	• Rectangular in through lane	<ul style="list-style-type: none"> <li>• Replace with diagonal quadrupole in through lane</li> <li>• Mark loop with pavement marking (if it can be adjusted to detect bikes)</li> <li>• Add small loop in proper location and mark with pavement marking</li> <li>• Change to pre-timed*</li> </ul>
Street w/left-turn lane***	• Rectangular in left-turn lane	<ul style="list-style-type: none"> <li>• Replace with diagonal quadrupole</li> <li>• Mark loop with pavement marking (if it can be adjusted to detect bikes)</li> <li>• Add small loop in right side of left-turn lane and mark with pavement marking</li> <li>• Change to pre-timed*</li> </ul>

\* Pavement markings can encourage bicyclists going straight to use the through lane instead of the right-turn lane. Or consider a short stretch of bike lane left of turn lane.

\*\*Pre-timed signals should be used only if bicycle volumes are very high.

\*\*\*Pavement markings can help encourage left-turning bicyclists to use the turn lane.

The diagram below at left shows the three primary options for detector loops. Note that the rectangular, or “standard” loop is only recommended for advance detection loops, placed some distance from the intersection. At intersections, the quadrupole or diagonal quadrupole are suggested, depending on whether bike lanes are present.

The diagram given below at right shows the most common pavement marking used to identify a bicycle-sensitive location. Over a standard loop, it is typically placed with the solid lines above the right-most wire of the loop. Over a quadrupole loop, it is typically placed with the solid lines above the center wires.

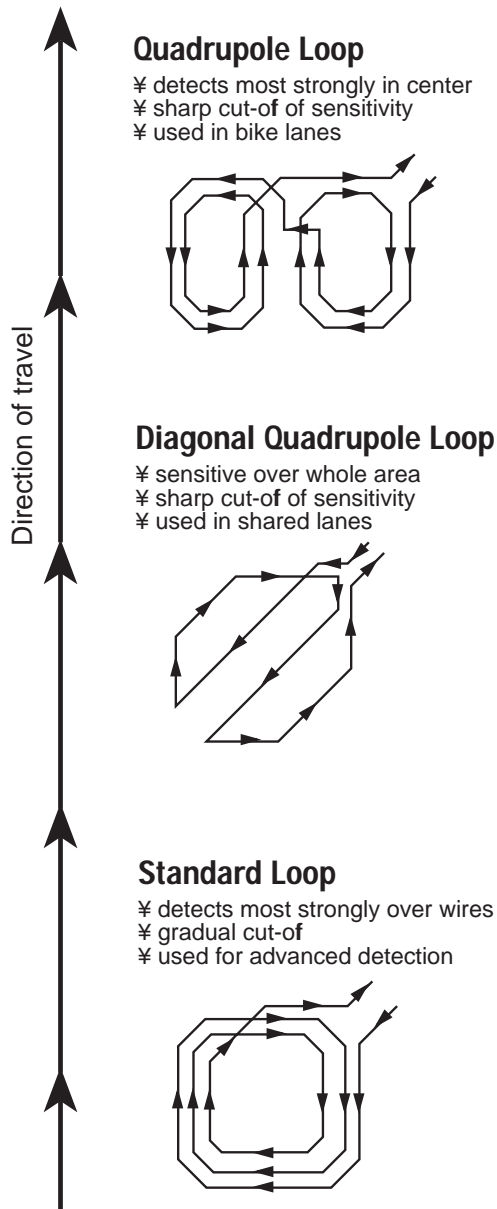

Figure 9.1

Three primary options for detector loops

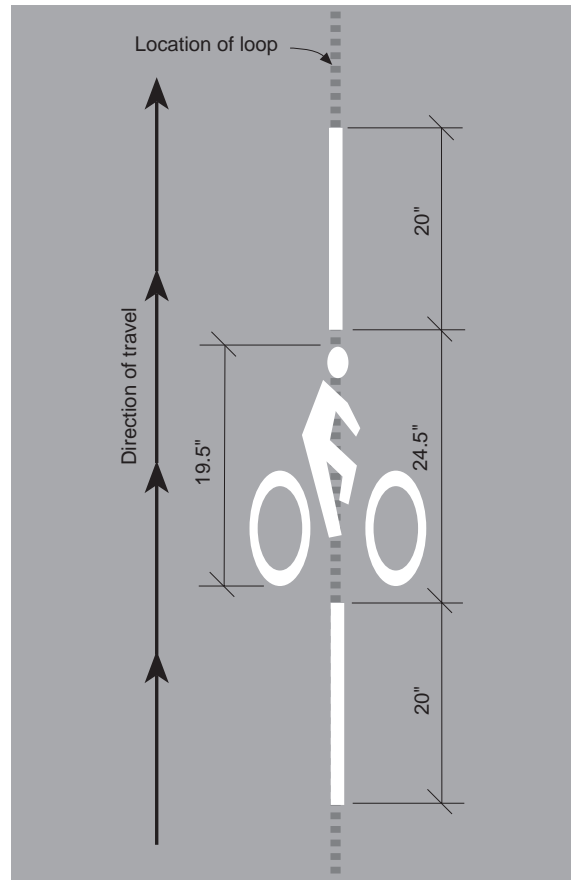

Figure 9.2

Pavement marking to identify a bicycle-sensitive location

## Adjusting Signal Heads for Bicyclists

Since bicyclists are expected to obey traffic signals, bicyclists, when properly positioned on the road, should be able to see them. Adjusting signal heads, especially programmed visibility heads that are designed to have a finite field of view, involves having someone stand in a location where bicyclists may be expected to wait for a signal indication and attempt to read the signal. The appropriate locations will generally be either within a bicycle lane or near the right-hand edge of the roadway. The following quote from the *Manual on Uniform Traffic Control Devices* (1988) provides guidance for accommodating bicyclists with such adjustments.

“At installations where programmed signals are used, special attention should be given to adjusting the signals so bicyclists on the regular bicycle lanes or travel paths can see the signals. If programmed signals cannot be aimed to serve the bicyclist, then separate signals shall be provided.” (MUTCD, 1988. Sec. 9D-1.)

## Signal Timing

The draft of the 3rd edition of the AASHTO *Guide* suggests that where bicycle traffic exists or is anticipated, setting the timing of traffic signals to accommodate bicyclists should be considered. AASHTO provides the following guidance regarding signal timing for bicyclists.

“In mixed traffic flow the bicyclist normally can cross the intersection under the same signal phase as for motor vehicles. The greatest risk to bicyclists is during the clearance interval and during the actuated phases during periods of low traffic flow. Signals should be designed to provide an adequate clearance interval for bicyclists who enter at the end of the green; and a total crossing time (minimum green plus clearance interval) long enough to accommodate bicyclists starting up on a new green.

“The length of the yellow change interval is dependent upon the speed of approaching traffic. Yellow change intervals adequate for motorists (generally 3.0 s to 6.0 s) are usually adequate for bicyclists. Generally, an all red clearance interval is not required, but can be used following the yellow clearance interval. The all red clearance interval normally ranges from 1.0 s to 2.0 s. The total clearance interval (yellow change interval plus red clearance interval) can be calculated from:

$$y + r_{\text{clear}} \geq t_r + v/2b + (w + l)/v$$

where:

y = yellow interval

r<sub>clear</sub> = red clearance interval

t<sub>r</sub> = reaction time (1.0 s)

v = bicyclist speed

b = bicyclist braking deceleration (1.2 to 2.5 m/s<sup>2</sup>)

w = width of crossing

l = bicycle length (about 1.8 m)

“If field observations are not available, approximately 98 percent of cyclists should be able to clear signals timed for the following speeds: 19 km/h (5.3 m/s) for Group A cyclists, 13 km/h (3.6 m/s) for Group B cyclists, and 10 km/h (2.8 m/s) for group C cyclists. Approximately 85 percent of cyclists can clear signals timed for speeds 20 percent higher. If local practice does not permit a red clearance interval this long (as given by the

equation), the longest red clearance interval consistent with local practice should be used.

“Signal clearance intervals should be sufficient for the bicyclist to react and stop safely, or pass through the intersection on the clearance interval. The general equation to determine the minimum green time is:

$$g + y + r_{\text{clear}} \geq t_{\text{cross}} = t_r + v/(2a) + (w + l)/v$$

where:

$g$  = minimum green

$y, r_{\text{clear}}$  = yellow and red clearance intervals actually used

$t_{\text{cross}}$  = time to cross the intersection

$t_r$  = reaction time (2.5 s)

$v$  = speed (at full speed)

$a$  = bicycle acceleration (0.5 to 1.0 m/s<sup>2</sup>)

$w$  = width of crossing (m)

$l$  = bicycle length (1.8 m)

“However, as with all calculated signal timing, actual field observations should be undertaken prior to making any adjustments to the minimum green or clearance intervals. Acute angle intersections require longer crossing times for bicyclists.” (*AASHTO Guide for the Development of Bicycle Facilities*, Draft, 3rd edition)

## REFERENCES

- Guide for the Development of Bicycle Facilities*, AASHTO, 1998 (pending)
- Manual on Uniform Traffic Control Devices*, FHWA, 1988
- Oregon Bicycle Plan*, ORDOT, 1992
- Technical Note: Bicycles & Traffic Signals*, Bikecentennial, 1989
- Traffic Signal Bicycle Detection Study*, City of San Diego, 1985

# DRAINAGE GRATES AND UTILITY COVERS

*Grates and covers that are not flush with the roadway surface can stop or divert a cyclist's front wheel, causing wheel damage and/or a serious crash.*



## PROBLEM STATEMENT

**D**rainage grates and utility covers can cause serious problems for bicyclists in several ways. Raised or sunken grates or covers can stop or divert a cyclist's front wheel, causing wheel damage and/or a serious crash. A related problem involves old-style parallel bar drainage grates, which can trap the front wheel of a bicycle, causing the bicyclist to be pitched over the handlebars.

## SOLUTION STATEMENT

Grates or covers that are not level with the roadway surface can be brought to the proper grade through raising or lowering, depending on the situation. In addition, on new construction the problem can be ameliorated through judicious placement of utilities; by keeping them out of bicyclists' most common path of travel (i.e., away from the right side of the roadway), problems can be reduced in frequency, if not in severity.

Parallel bar drain grates can be replaced with modern bicycle-safe and hydraulically efficient models, like the "vane" or "honeycomb" grates (see images later in this section). When it is possible to do more than simply replace a grate, installing curb face inlets can move the inlet out of the roadway entirely. These must be designed carefully to minimize cross slopes, which, if excessive, can throw bicyclists toward the curb.



## IMPLEMENTATION STRATEGIES

There are two primary approaches necessary when addressing drainage grate and utility cover problems. First, existing problem locations must be identified and corrected according to a well-developed and prioritized plan of action.

Second, design standards must be modified, as needed, to keep similar problems from arising in the future. It is far more cost-effective to design with bicyclists in mind than to retrofit solutions later.

## OBJECTIVES

To eliminate drainage grate and utility cover hazards for bicyclists:

- By replacing parallel bar drainage grates with bicycle-safe models.
- By adjusting grates or utility covers that are above or below the level of the surrounding roadway.
- By adopting bicycle-safe design standards for drainage grates on all new construction.
- By adopting bicycle-safe standards for leveling utility covers and drainage grates.
- By encouraging the location of utilities away from the normal path for bicyclists.

## RESOURCE REQUIREMENTS

For the most part, the resources needed for this project are easily obtained. Bicycle-safe drainage grate models are available from most commercial foundries, and the hardware necessary to raise or lower manhole covers or utility covers may be found in most relevant agencies' inventories.

## SUBTASKS

### 1. Review standards for drainage grates, utility cover adjustment, and utility locations

Identify standards used by local public work agencies in their drainage work. Compare the requirements to the bicycle-safe approaches described in the Specifications section below. Unsuitable design should be replaced with better information.

### 2. Determine the likely scope of the problem

If parallel bar drainage grates have not been used for years, it is possible that only a few remain. If, on the other hand, they are still in use, it is likely to be a major problem. Research into agency records will give a sense of the magnitude of the problem.

### 3. Identify hazardous locations on popular bicycling routes

While all hazardous installations should be improved, the best place to start is on either existing or planned bicycle facilities or on popular bicycling routes. These should be as free of bicycling hazards as possible.

#### 4. Replace hazardous installations whenever field work is done

When storm sewer work is done, correct bicycle-related problems as part of the scope of the project. Field personnel should make this a routine part of their activities.

#### 5. Set up an on-going hazard identification program

To catch problems that agency personnel would otherwise miss, enlist the help of the bicycling public. Through such approaches as “bicycle hazard postcards” left in bicycle shops or publicity sent through local bicycle clubs, it is possible to extend the agency’s effectiveness in solving bicycling problems.

#### 6. Evaluate results

On at least an annual basis, determine what progress has been made toward the goal of eliminating unsafe grates and utilities. Consider the number of grates replaced, the current design standards, and the extent of changes in utility location.

## SCHEDULE

For the most part, this program requires an on-going commitment to making bicycle-related improvements part of the routine business of storm sewer and utility work.

## SPECIFICATIONS

### Drainage grates

Numerous designs have been developed over the years that eliminate the dangers of the parallel bar grate, while at the same time maintaining hydraulic efficiency. Here are three of the most popular:

- Vane grate (e.g., Neenah Foundry Type L)
- Honeycomb grate (e.g., the CalTrans Standard Grate)
- Curb face inlets

*Figure 10.1 Drainage grates*

*Vane grates are being used in grate replacement programs in many cities throughout the country, not only because of their storm water capacity but also for their bicycle-safe qualities. When the grate is installed properly with the vanes perpendicular to the curb line, the bicyclist passes over a series of bars rather than into a parallel long slot.*

*Vane grates should not be installed in driveway entry areas of the roadway unless longitudinal bars have been added for bicycle safety.*

*Vane grate design*



*Honeycomb grate design*



*Curb face inlet design*



Images courtesy  
Neenah Foundry

Other options identified in various references include pavement markings that direct bicyclists around dangerous grates (see diagram below) and retrofitting parallel bar grates with welded straps every 15 cm (6 in) to keep bicycle wheels from falling in. When used, straps should be welded perpendicular to the line of bicycle travel. However, pavement markings are temporary solutions at best. Paint wears off and bicyclists may not notice the marking under certain lighting conditions. In addition, they may be

Figure 10.2

*Pavement marking in advance of a drainage hazard*

Source: North Carolina Bicycle Facilities Planning and Design Guidelines: after MUTCD, p. 9C-6

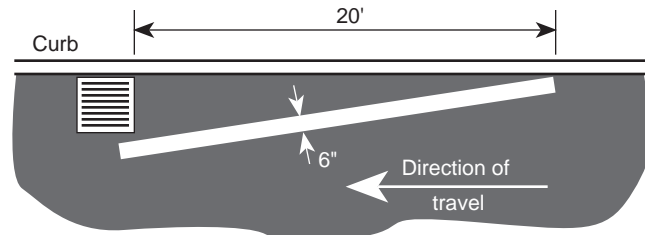

forced to continue over the grate by passing traffic.

Welded straps, likewise, are temporary measures. Passing traffic can pop the bars loose, producing a double hazard for bicyclists. In addition, the costs of field repairs to drainage grates must be compared with the costs of replacement. When all the costs are analyzed, it may well be that replacement is less expensive than repair.

### Uneven grates or utility covers

The solution to this problem is to adopt a standard for manhole and utility cover adjustment, similar to that shown below. Raising or lowering the cover is one option while feathering the new paved surface to match the cover height is another. In addition to making sure utility cover height is

Figure 10.3

*Standard height adjustment for storm sewer cover solves a problem for bicyclists*

Source: Montana Public Works, 1988

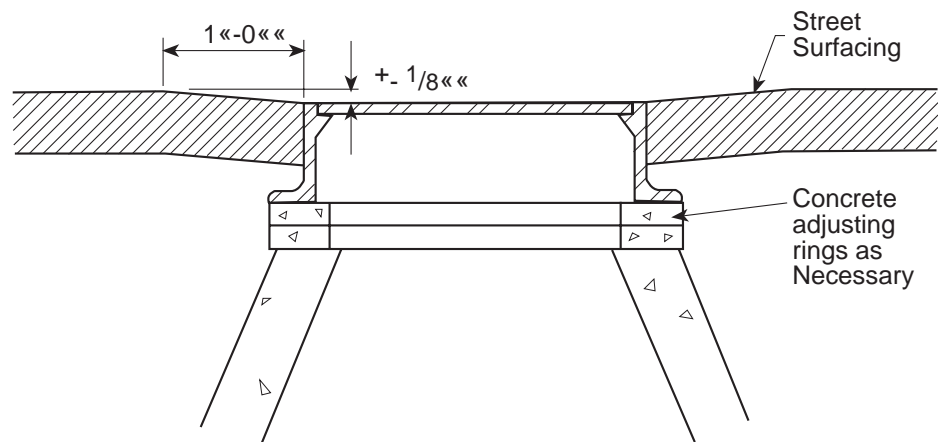

proper, to the extent possible, new utilities should be installed away from the expected line of travel for bicyclists.

### Utility locations

In general, bicyclists travel along either the right side of the outside travel lane or on the paved shoulder. To the extent possible, utilities should not be

located in these areas. Further, if bicycle lanes are present, the utilities should not be within these lanes.

Drainage grates, however, must be located near the curb and, for this reason, must be bicycle safe. In some areas, the curb and drainage structure may be offset further to the right to allow bicyclists to pass without obstruction (see diagram at right).

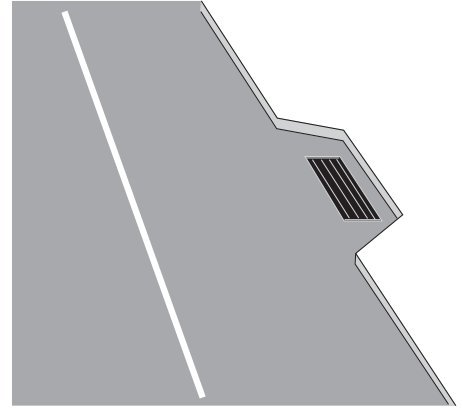

*Figure 10.4*

*Offset drainage structure*

## REFERENCES

- Bicycle-Safe Grate Inlets Study*, FHWA, 1977  
*Construction Castings Catalog*, Neenah Foundry Company, 1995  
*MTPublic Works, 3rd Edition, 1988*, MTPublic Works Association  
 “The Grates of Cincinnati,” Don Burrell, *Bicycle Forum*, 1986



# RURAL ROAD SHOULDERS

*Smoothly paved shoulders adjacent to the travel lanes can greatly improve conditions for bicyclists along rural highways.*



## PROBLEM STATEMENT

**W**hile rural roads seldom serve large numbers of bicyclists, they are often the only connections between points A and B. Thus, bicyclists who, for example, live on a farm and want to ride to town will have relatively few options, compared to bicyclists who live in town and want to ride to the store. In addition to having few options, rural bicyclists may have to contend with high speed traffic and, in some key instances, high traffic volumes with significant percentages of truck traffic. To further exacerbate the problem, the roadway itself may be narrow with damaged pavement and debris deposits near the right edge, and drainage ditches or rough gravel verges immediately adjacent to the edge of pavement.

Other bicycle users known to frequent rural roadways include touring bicyclists, racing cyclists on training rides, and those out for a day's recreational ride. In some parts of the country, these users can be quite numerous, particularly on certain routes and during certain times of year.

## SOLUTION STATEMENT

Smoothly paved shoulders adjacent to the travel lanes can significantly improve the situation for bicyclists. They can provide a reasonably safe area for bicyclists to ride that is out of the stream of high-speed motor vehicle traffic. Further, shoulders can provide a buffer between bicyclists and the turbulence created by passing trucks. But paved shoulders can help non-bicyclists as well. Studies have shown that they can reduce roadway maintenance costs and run-off-the-road motor vehicle crashes.

The AASHTO has enumerated many benefits of well-designed and properly maintained shoulders on rural highways (A Policy on Geometric Design of Highways and Streets, 1991, AASHTO, p.337). Most of the benefits accrue to motorists. The 14 points are as follows:

1. Space is provided for stopping free of the traffic lane because of mechanical difficulty, a flat tire, or other emergency.
2. Space is provided for the occasional motorist who desires to stop to consult road maps, to rest, or for other reasons.
3. Space is provided to escape potential accidents or reduce their severity.
4. The sense of openness created by shoulders of adequate width contributes much to driving ease and freedom from strain.
5. Sight distance is improved in cut sections, thereby improving safety.
6. Some types of shoulders enhance the aesthetics of the highway.
7. Highway capacity is improved; uniform speed is encouraged.
8. Space is provided for maintenance operations such as snow removal and storage.
9. Lateral clearance is provided for signs and guardrails.
10. Storm water can be discharged farther from the pavement and seepage adjacent to the pavement can be minimized. This may directly reduce pavement breakup.
11. Structural support is given to the pavement.
12. Space is provided for pedestrian and bicycle use.
13. Space is provided for bus stops.
14. Improved lateral placement of vehicles and space for occasional encroachment of vehicles is provided.

## IMPLEMENTATION STRATEGIES

Providing smoothly paved shoulders on rural roads is typically done in one of three ways. First, shoulders are often provided as part of the construction of a new road or a reconstruction project. This is, typically, the least expensive way to provide shoulders; when included as an original part of a larger project, shoulder provisions can benefit from possible savings in right-of-way acquisition, utility relocation, grading, and paving that, in many cases, must be done anyway.

The second alternative is to provide shoulders as an independent project. While this may well prove more expensive than including shoulders when a road is constructed or reconstructed, there are instances where it should be done anyway. For example, consider the case where development overtakes a previously adequate two-lane rural road. A new park may be built near a school and a subdivision may go in just up the road. As a result of these use changes, the road may well start attracting higher levels of bicycle traffic than previously. And, while there may be plans to improve the roadway in the long term, such a project may be 10 or 20 years off.

Third, shoulders may be provided as part of an overlay project.

In addition, rural road design standards could be modified to provide adequate paved shoulders as part of the typical cross section.

## OBJECTIVES

To provide adequately paved shoulders on rural roads:

- By including such shoulders wherever possible in new construction, reconstruction, and overlay projects.
- By independently adding paved shoulders to existing roadways where sufficient need has been identified.
- By adopting design standards for rural roads that include reasonably wide and smoothly paved shoulders.
- By restricting the use of rumble strips and other similar devices where bicycle traffic is expected.
- When shoulders cannot be provided immediately, by locating utilities and drainage structures far enough from the roadway to allow for eventual paving.

## RESOURCE REQUIREMENTS

Providing smoothly paved shoulders requires no special resources or skills. It is simply a matter of following commonly understood engineering practice and budgeting adequate funding for the extra paving and other needs.

## SUBTASKS

### 1. Review design standards for rural roadways and highways

Identify typical cross sections used by public work agencies in rural road and highway work. Compare the requirements with bicycle-safe approaches described in the Specifications section below. Unsuitable designs should be replaced with better ones.

### 2. Determine the likely scope of the problem

Determine the approximate mileages of the different categories of rural roads that do not include paved shoulders.

### 3. Identify high priority locations

While all hazardous locations should eventually be improved, the best place to start is on popular bicycling routes, connections between important destinations (e.g., schools and housing developments), and locations where bicycle safety problems have been previously identified.

### 4. Include smoothly paved shoulders on new construction and reconstruction projects

When new roads are built or current ones are renovated, specify smoothly paved shoulders as part of the typical cross section.

### 5. Set up an on-going shoulder program

Identify those problem locations that are not likely candidates for inclusion



in currently planned road construction or reconstruction projects. Prioritize these and budget a set amount for shoulder provision each year.

## 6. Evaluate results

On at least an annual basis, determine what progress has been made toward the goal of providing adequate shoulders on rural roads. Consider the number of miles of shoulder paved, changes to the current design standards, and the proportion of new construction and reconstruction projects that include adequate shoulders.

## SCHEDULE

For the most part, this program requires an on-going commitment to making bicycle-related improvements part of the routine business of road building and renovation.

## SPECIFICATIONS

### Shoulder width

To accommodate bicyclists, a minimum paved shoulder width of 1.2 m (4 ft) should be provided. However, paved shoulders that are as narrow as 0.9 m (3 ft) can also help improve conditions for bicyclists and are recommended where 1.2-m (4-ft) widths cannot be achieved. Generally, any additional paved shoulder width is better than none at all. The width of a usable paved shoulder should be measured from the edge of a gutter pan. Where guardrails, curbs, or other roadside barriers exist, the minimum recommended width of a paved shoulder is 1.5 m (5 ft). Additional shoulder width over the recommended minimums is always desirable where higher bicycle usage is expected; where motor vehicle speeds exceed 90 km/h (56 mi/h); where there is a high percentage of large vehicles such as trucks, buses and recreational vehicles; or where static obstructions exist at the right side of the roadway.

In general, the recommendations for paved shoulder widths found in AASHTO's A Policy on Geometric Design of Highways and Streets serve bicycles well since wide shoulders are required on heavily traveled, high-speed roads carrying large numbers of trucks.

To be useful for bicyclists, shoulders should be smoothly paved. A policy for paving rural shoulders as developed by the Wisconsin Department of Transportation appears on the next page.

### Paved surface

To encourage bicycle use, the surface of the shoulder should be at least as smooth as that of the adjacent travel lanes. Further, in order to ensure long-term utility, the paved section and subgrade should be structurally adequate for at least occasional motor vehicle use and should be adequately supported at the edge of pavement. In addition, seams should be smooth or, preferably, kept away from the shoulder area. And such devices as rumble strips should only be used when there is a documented safety problem and the needs of bicyclists may be served through, for example, provision of adequate extra width that is not rumbled.

## Shoulder continuity

Providing short stretches of shoulder connected by roadway sections with no shoulders does little to solve the problem. On the other hand, if including shoulders as incidental features of roadway reconstruction or overlay projects can provide important pieces of the puzzle, such opportunities should not be overlooked. The remaining sections can be connected at a later date to provide continuity at a substantially reduced cost.

Ultimately, shoulders should be provided continuously between logical origins and destinations. This includes providing adequate width on

### Wisconsin Department of Transportation's Rural Shoulder Policy:

*The policy for paving shoulders on two-lane rural state trunk highways shall be as follows:*

1. When constructing new highway surfaces or when resurfacing existing roadways, the shoulder next to designated driving lanes shall be paved on highways functionally classified as arterials, regardless of traffic volume. Shoulders on state trunk highways classified as collectors or locals and having a current ADT in excess of 1250 vehicles shall also be paved. The paved width shall be as shown in Figure 5 of this procedure.

2. Segments of highway having a current ADT in excess of 1,000 vehicles and consistently carrying bicycle traffic of 25 or more per day two ways during the normal bicycling season shall have the shoulders paved. See Procedure 11-45-10 for guidance on shoulder bikeways.

3. Shoulders may also be paved full width along highways in suburban areas where closely spaced driveways and/or frequent turning movements cause unpaved shoulders to require excessive maintenance.

4. Continuity of shoulder paving between logical termini is desirable. Gaps of unpaved shoulders should not be left due to a short segment of highway not meeting the warranting criteria. Similarly, if only a short segment of highway meets the warrants, than paved shoulders may not be appropriate. Also, for purposes of continuity and the closing of short gaps, it may be desirable to pave the shoulders on sections of highway where surfacing of traffic lanes may not be planned for several years, provided the shoulder paving is done in conjunction with surfacing or resurfacing an abutting highway segment.

5. On highways with existing narrow pavements when pav-

ing is warranted, the 3-ft. width shall be in addition to any widening to increase the width of traffic lanes.

6. The thickness of shoulder paving should be based on usual design considerations appropriate for each situation.

The above policy on paving shoulders is for rural state trunk highways only. Projects on county trunk highways which fit the above criteria may also have their shoulders paved at the discretion of local officials. If the shoulders of a county trunk highway are to be paved, the paved width shall conform to the dimensions given in Figure 5 of this procedure.

### Procedure 11-45-10: Shoulder Bikeways

Table 1 provides shoulder paving requirements to accommodate bicycles on rural two-lane state trunk highways. When shoulder bikeways are provided on four-lane divided expressways the paved shoulder width should be 10 feet.

Where a bike route is planned or located on a CTH [County Trunk Highway] or town road, the paved width, if any, should be determined by the local government.

**Table 1:** Rural Two-Lane State Trunk Highway Paved Shoulder Width Requirements to Accommodate Bicycles

Motor Vehicle ADT	Bicycle ADT	
	0-24	≥25
Under 1000	0 <sup>1</sup>	0 <sup>1</sup>
1000 - 1250	0 <sup>1</sup>	5ft.
Over 1250	Varies <sup>1,2</sup>	5ft. <sup>1</sup>

1 See Figure 5 of Procedure 11-15-1 for other shoulder paving standards not related to bicycles.

2 For Great River Road only, paved shoulders 5ft. wide. See Procedure 11-15-5

bridges and other structures. In addition, the benefits to be gained from the use of shoulders for right-turn-only lanes should be carefully weighed against the consequences for bicyclists.

## Debris

Debris on a paved shoulder can render it unusable for bicyclists. Broken glass can easily destroy tires, gravel can cause loss of control, and rocks can wreck a wheel. Careful design can eliminate many of the problems by, for instance, paving 4.5 m to 6.1 m (15 to 20 ft) into intersecting gravel roads,

providing extra width and, perhaps, garbage cans in areas where motorists are likely to pull off, and including barriers to intercept falling rocks. Maintenance can help as well. However, it is often better to design in low-maintenance solutions than to require frequent sweeping or cleaning.

## REFERENCES

*ABCs of Bikeways*, MDDOT, 1977

*A Policy on Geometric Design of Highways and Streets*, AASHTO, 1998 (pending)

*Facilities Development Manual: "Shoulder Bikeways,"* WISDOT, 1993

*Guidelines for Wide Paved Shoulders on Low-Volume, Two-Lane Rural Highways*, Woods, Rollins, & Crane, TRB, 1989

"Rumble Strips and Bicycle Wheels," John Williams, *Bicycle Forum*, 1987

# BICYCLE PARKING

*Secure bicycle parking is a key ingredient in efforts to encourage bicycling at the local level.*



## PROBLEM OVERVIEW

Providing secure bicycle parking is a key ingredient in efforts to encourage bicycling at the local level. Many bicycle journeys end somewhere other than the bicyclist's home and, as a result, the bicyclist must park his or her bicycle. For those who live in apartment complexes, college dormitories, or other high-density settings, the issue of where to leave a bike while home is also a serious issue. In short, at one time or another most bicyclists have experienced the frustration of finding no secure place to leave their bikes.

Some have experienced the even greater frustration of returning to find their bicycles stolen. In fact, statistics compiled by the Federal Bureau of Investigation show that between 1988 and 1992, an average of approximately 450,000 bicycles were reported stolen each year. These figures are low, according to the Lock Smart Campaign, which estimates that roughly twice as many are stolen but never reported. They suggest that, with an average cost of \$380 per bike, the financial loss to American bicyclists amounts to some \$450 million per year.

While providing secure bicycle parking is not the entire solution to the problem of theft, it certainly can help and it can increase bicyclists' comfort in leaving their bicycles unattended. As a result, many bicycle owners may be encouraged to make bicycle trips they might otherwise forego.

## SOLUTION OVERVIEW

Bicycle parking can be provided in a wide variety of settings using three basic approaches: bicycle racks (open-air devices to which a bicycle is locked); bicycle lockers (stand-alone enclosures designed to hold one bicycle per unit); and bicycle lock-ups (site-built secure enclosures that hold one or more bicycles). See page 90 for two types of bicycle parking devices.

For short-term parking, bicycle racks work well. At sites that require long-term parking for a variety of potential users, lockers are the devices of choice. For long-term parking for a limited number of regular and trustworthy users, bicycle lock-ups can solve the problem.

## OBJECTIVES

1. To provide well-located secure bicycle parking at popular destinations in business districts and at other public sites:
  - By installing bicycle parking at public centers.
  - By installing bicycle parking on public rights-of-way in neighborhood commercial and downtown business districts.
  - By encouraging private businesses to provide bicycle parking for their customers.
  - By installing bicycle parking at transit stops and in parking garages.
  - By encouraging the installation of high-security bicycle parking at existing worksites, schools, and high-density residential developments.
2. To require new commercial, public, and high-density residential developments to include plans for bicycle parking:
  - By adding provisions to local zoning regulations requiring bicycle parking as part of new developments, particularly commercial, public, and high-density residential developments.
  - By making these requirements part of the process of getting a building permit.

## IMPLEMENTATION STRATEGIES

Implementing bicycle parking in a community requires a combination of three primary strategies: 1) acquiring and installing bicycle parking devices on public rights-of-way or at public destinations (e.g., city hall, libraries, and parks); 2) encouraging businesses to provide bicycle parking for their customers; and 3) altering zoning regulations to ensure bicycle parking is provided in new developments. Typically, the first strategy helps “prime the pump” for the second; and the third strategy helps ensure long-term improvements in newly developed areas.

## SUBTASKS

### 1. Identify key implementors

Each of the three implementation strategies requires the cooperation of a different group of constituencies. To put bicycle parking in public places requires the cooperation of agencies that control the land involved. Side-

walks may be controlled by the streets or public works department while parks and recreation may have responsibility for public open spaces and recreational sites. There may be an agency in charge of all public property. Alternately, agencies that run specific services (e.g., the library, public health clinics) may control their own sites.

Encouraging businesses to install bicycle parking requires the cooperation of such groups as the Chamber of Commerce, downtown business associations, and shopping center managers. In addition, agencies that routinely deal with businesses should be enlisted as outlets for any literature developed as part of the program.

Altering zoning regulations to require consideration of bicycle parking in new developments requires close cooperation with planning and zoning agency staff, as well as assistance from appointed zoning boards and builders' associations. Typically, regulations are revised on a schedule; therefore, the opportunity to revisit parking requirements may or may not be imminent.

## 2. Structure the program

In some communities, a reactive program that simply fills orders and answers questions can prove successful. This would be most likely in a “bicycle town” with a high degree of interest in bicycling matters. However, in many places, such a passive approach would result in little response. Business owners and managers of large employment centers or residential complexes often see bicycles as clutter and “problems” to eliminate rather than as solutions to traffic congestion or air quality problems. As a result, a successful bicycle parking program should include elements of marketing and promotion.

With the help of the key players identified in Subtask 1, create three adhoc task groups covering each of the three primary thrusts. The groups should create the ground rules and materials necessary for the following tasks:

### ***Task Group 1: public bicycle parking***

- Install bicycle parking at public centers
- Install bicycle parking on public rights-of-way
- Install bicycle parking at transit stops and in parking garages

### ***Task Group 2: private bicycle parking***

- Encourage private businesses to provide bicycle parking for their customers
- Encourage installation of high-security bicycle parking at worksites, schools, and high-density residential developments

### ***Task Group 3: zoning regulation revision***

- Add provisions to local zoning regulations requiring bicycle parking
- Make these requirements part of the process of getting a building permit

## 3. Choose appropriate bicycle parking devices

As one of the first tasks, assemble packets of information on available bicycle parking devices, along with pros and cons for endorsing each device.

In a joint meeting(s) with all three task groups, adopt a set of criteria and decide which devices to endorse. A set of possible criteria are listed in the Specifications section given on page 91. Next, give each task group its marching orders. They are as follows:

#### 4. Tasks for Task Group 1: public bicycle parking

Task Group 1 should set criteria for installing bicycle parking devices on sidewalks, as well as at public destinations. For sidewalks, criteria could include such things as minimum width of sidewalk, rack position on sidewalk and proximity to other street furniture and vegetation, number per block or number per site. For public sites, they could include proximity to the main entrance, and minimum number of bicycle parking spaces per installation (perhaps keyed to type of facility served).

Next, they should create an agreed-upon step-by-step procedure for planning and installation. This should include initial identification of the potential site, discussion with relevant agency personnel, determination of the specific site's needs (number of parking devices and location), cost analysis and budgeting, procurement, installation, and follow-up.

To support this activity, they should create a project sheet for rack installation that includes places for the source of the request (if any), signatures of any required agency personnel, a schematic diagram of site, installation date, and any comments.

Next, they should estimate the total bicycle parking need for public places, given a list of potential sites. Estimates can be conservative and based to some extent on existing bicycle traffic, as long as participants realize that latent demand may be significant. For this reason, phased installations can be particularly appropriate.

For sidewalks, a base number of racks to be installed during the fiscal year (e.g., 100, 500, 1000) should be decided upon, along with a map showing area priorities. Downtown might, for instance, be a top priority area, neighborhood commercial areas could be second, and strip development areas might be third.

Finally, the Task Group should set an annual budget for the program and decide how the bicycle parking should be paid for. Potential sources include a wide variety of Federal transportation programs, as well as local funding opportunities.

#### 5. Tasks for Task Group 2: private bicycle parking

Task Group 2 should assemble a packet of information for potential private sector bike parking providers. The packet should include a cover letter describing the importance of bicycle parking to businesses and giving any organizational endorsements for the program; a list of available parking devices, along with information on how to order them and which are best suited for which settings; tips on deciding how many bikes need to be accommodated; and tips on locating and installing the devices.

The Task Group should also work out details of any promotional activities that will need to be planned. For instance, they should develop a list of groups to talk with, determine who should be responsible for reaching each one, and start making contacts. To this end, the Task Group should develop a standard presentation, possibly including slides and handouts.

#### **Funding Bike Rack Installation:**

One small city started a cooperative downtown bike parking program in which the engineering department did the installation while the redevelopment agency bought the racks. The rack purchasing budget was approximately \$2500 per year and installation cost slightly less. With approximately \$5000 per year in funding, the city was able to install 50 racks each year. Over the past decade, they have installed between 400 and 500 racks in this manner.

Other cities have created ambitious programs using money provided under the Intermodal Surface Transportation Efficiency Act. For example, one large midwestern city used nearly \$1 million of its Congestion Mitigation/Air Quality Program money to install several thousand bike racks around the community.

## 6. Task Group 3: zoning regulation revision

This Task Group should start by identifying passages in the existing zoning codes where motor vehicle parking is discussed. They should find out when the regulations are going to be next modified and use that in determining their schedule of work. They should next assemble sample bicycle parking laws or ordinances from other communities. Based on the sample laws, they should create a draft revision to the regulations and circulate it for comment. Once comments have been received and considered, they should forward a final draft revision for action at the proper time.

## 7. Implement the program

With the program set up, materials at the ready, and initial funding identified, implementing the program can begin. Routine responsibilities for the various tasks should be taken care of by the agencies identified through the previous steps. Oversight of the program may require the attention of a project coordinator. This may be a task delegated to a member of the planning or public works staff.

## 8. Evaluate progress

As the work is proceeding, keep track of successes and failures. Early on, get the word out to the bicycling public that 1) the program exists; and 2) that they should submit comments and ideas for potential parking sites. Keep records on how many parking devices have been installed, how many comments have been received, how many information packets have been sent out, what proportion of public places have adequate bicycle parking, how well the parking is working (e.g., whether the public likes it, whether it holds up well to vandalism), and how successful the zoning regulations appear to be (once they are adopted). Use this feedback in fine-tuning the program and determining future levels of funding.

## RESOURCE REQUIREMENTS

For the most part, bicycle parking requires basic equipment: racks and lockers. These can be ordered or fabricated in large or small quantities. Ordering in quantity can save money as long as storage needs can be satisfied until installation can be accomplished. Once a community gets actively involved in bicycle parking installation, it is quite possible that local sources will emerge. For instance, in some communities, welding shops make and sell approved bike racks on a routine basis. This not only helps agencies satisfy a growing bicycle parking demand but it can also lead to the development of new local industries.

## SCHEDULE

Installing bicycle parking at public places and on sidewalks can begin with little delay. Encouraging businesses to install bicycle parking, being more of a marketing and promotion activity, involves building interest over time and may not pay off for several years. Even longer term are the results of changes in zoning ordinances. At the same time, these changes can lead to the greatest overall effect.



Figure 12.1

**An inexpensive bicycle rack design**

The design shown at right has proved popular and effective in numerous communities. It is inexpensive to fabricate locally, easy to install, vandal-resistant, and works well with the popular high-security bicycle locks. In addition, it can be installed singly, as on a sidewalk, or in quantity, as at a major recreational center.

Schedule 40 steel pipe works well and, for best results, the rack should be galvanized after fabrication. Typical costs run about \$75 per rack installed, when purchased in quantities of 50 or more.

Adapted from Lubbock Metropolitan Area Comprehensive Plan, Bicycle Federation of America

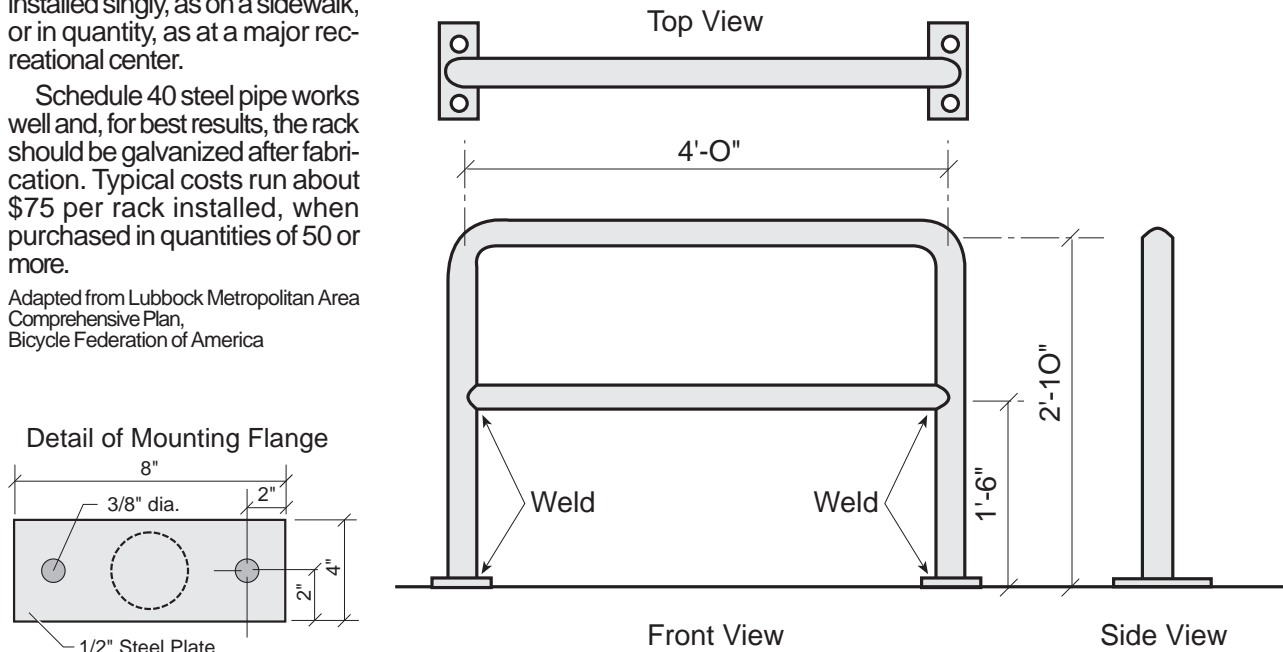

Figure 12.2

**Typical bicycle locker installation**

Bicycle lockers provide a higher level of security than do bicycle racks. They are the preferred option where long-term security is more important than short-term convenience. Work site locker installations for bike commuters are particularly welcome, as are installations at large residential complexes. Unlike racks, lockers provide protection for a bike's components, as well as the user's luggage and other belongings. Each locker unit is divided diagonally to allow separate storage for two bicycles.

Some agencies use coin operated units but the most popular approach is to rent the lockers on a monthly or quarterly basis or to provide them free. Lockers are generally installed in multiples of two or more units, since each installation requires a "starter unit," which is approximately twice the cost of subsequent units. Typical costs run \$3300 for starter units and \$1600 for add-on units. Each unit has two enclosures.

Adapted from Lubbock Metropolitan Area Comprehensive Plan, Bicycle Federation of America

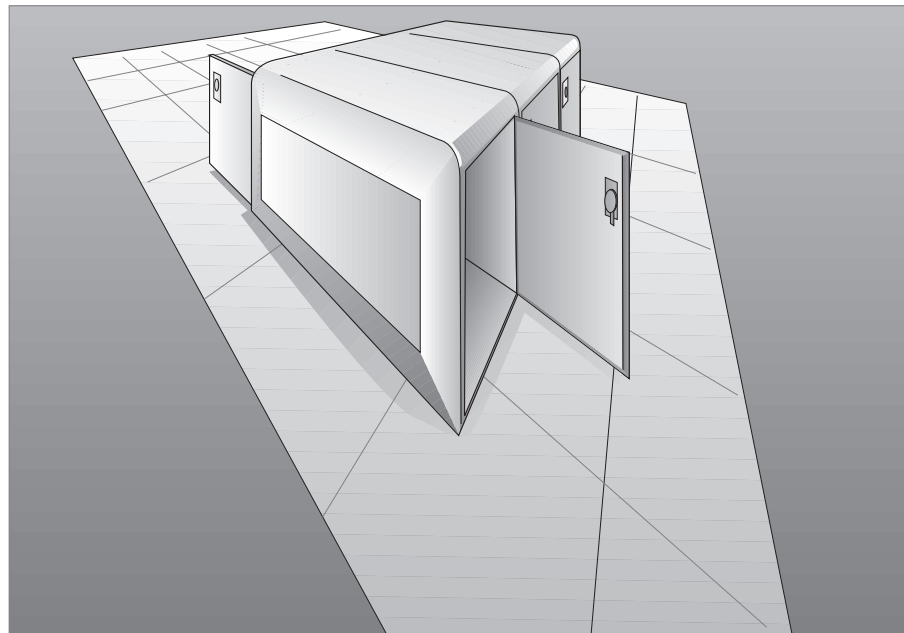

## SPECIFICATIONS

### Criteria for selecting bicycle parking devices

Selecting bicycle parking devices should be based on the following considerations, in addition to any special needs of the local community.

#### ***Bike racks***

- Security, especially how well the device works with common bike locks
- Durability and resistance to vandalism
- Ease of use
- Aesthetics
- Cost

#### ***Bike lockers***

- Security
- Durability
- Aesthetics
- Cost

## REFERENCES

*Bicycle Parking*, Ellen Fletcher, 1990

*Source Book of Designs, Manufacturers and Representatives*, Bicycle Federation of America, 1992

Technical Notes: *Bicycle Parking Location; Choosing Parking Devices; A Simple Bike Rack Design; Bike Parking Ordinances*, Bikecentennial, 1987-'89

**Sample bike parking ordinance from Madison, Wisconsin**

A growing number of communities have included bicycle parking requirements in their development regulations. By so doing, they ensure that bicycle parking is included in the normal course of development. This example is from the Madison City Code.

**Purpose**

...  
 (d) Providing adequate and safe facilities for the storage of bicycles.

...  
 4. Bicycle parking facilities shall be provided as required for all new structures and uses established as provided in Sec. 28.11(2)(a)1. or to changes in uses as provided in Secs. 28.11(2)(a)2. and 3.; however, bicycle parking facilities shall not be required until the effective date of this paragraph. Notwithstanding Secs. 28.08(1)(i) and 28.09(5)(a), bicycle parking facilities shall be provided in all districts including districts in the Central Area.

...  
 1. In the residential district, accessory off-street parking facilities provided for uses listed herein shall be solely for the parking of passenger automobiles and bicycles of patrons, occupants or employees and not more than one truck limited to one (1) ton capacity.'

...  
 (e) Size. ... Required bicycle parking spaces shall be at least 2 feet by 6 feet. An access aisle of at least 5 feet shall be provided in each bicycle parking facility. Such space shall have a vertical clearance of at least 6 feet.'

...  
 d. Bicycle Parking Facilities. Accessory off-street parking for bicycles shall include provision for secure storage of bicycles. Such facilities shall provide lockable enclosed lockers or racks or equivalent structures in or upon which the bicycle may be locked by the user. Structures that require a user-supplied locking device shall be designed to accommodate U-shaped locking devices. All lockers and racks must be securely anchored to the ground or the building structure to prevent the racks and lockers from being removed from the location. The surfacing of such facilities shall be designed and maintained to be mud and dust free.

...  
 3. Bicycle parking facilities shall be located in a clearly designated safe and convenient location. The design and location of such facility shall be harmonious with the surrounding environment. The facility location shall be at least as convenient as the majority of auto parking spaces provided.

...  
 1. Bicycle parking facility spaces shall be provided in adequate number as determined by the Zoning Administrator. In making the determination, the Zoning Administrator shall consider when appropriate, the number of dwelling units or lodging rooms, the number of students, the number of employees, and the number of auto parking spaces in accordance with the following guidelines (see chart at left).'

**Off-Street Bicycle Parking Guidelines**

Land Use	Bike Space
Dwellings/lodging rooms	1 per dwelling unit or 3 lodging rooms
Clubs/lodges	1 per lodging room plus 3% of person capacity
Fraternities/sororities	1 per 3 rooms
Hotels/lodging houses	1 per 20 employees
Galleries/museums/libraries	1 per 10 auto spaces
Colleges/universities/junior and high schools	1 per 4 employees plus 1 per 4 students
Nursery/elementary schools	1 per 10 employees plus students above secondgrade
Convalescent and nursing homes/institutions	1 per 20 employees
Hospitals	1 per 20 employees
Places of assembly, recreation, entertainment and amusement	1 per 10 auto spaces
Commercial/manufacturing	1 per 10 auto spaces
Miscellaneous/other	To be determined by the Zoning Administrator based on the guideline for the most similar use listed above

"a. In all cases where bicycle parking is required, no fewer than two (2) spaces shall be required.

"b. After the first fifty (50) bicycle parking spaces are provided, additional bicycle parking spaces required are 0.5 (one half) space per unit listed.

"c. Where the expected need for bicycle parking for a particular use is uncertain due to unknown or unusual operating characteristics of the use, the Zoning Administrator may authorize that construction and provision of not more than fifty (50) percent of the bicycle parking spaces be deferred. Land area required for provision of deferred bicycle parking spaces shall be maintained in reserve."

# BICYCLE-RELATED MAINTENANCE



*Surface problems that may go unnoticed by motorists can deter and/or be hazardous for cyclists.*

## PROBLEM OVERVIEW

**B**icycles and bicyclists tend to be particularly sensitive to maintenance problems. Most bicycles lack suspension systems and, as a result, potholes that motorists would hardly notice can cause serious problems for bicyclists. In addition, since bicyclists often ride near the right margin of the road—sometimes as required by traffic law—they use areas that are generally less well maintained than the main lanes. On higher speed roads, the passage of motor vehicle traffic tends to sweep debris to the right, again where most bicyclists travel. In addition, ridges, like those found where a new asphalt overlay does not quite cover the older roadway surface, can catch a wheel and throw a bicyclist to the ground.

Aside from these general problems, special bicycle facilities often need more maintenance than they receive. Bicycle parking devices are particularly susceptible to misuse or neglect. On trail systems, for example, vegetation is often allowed to overgrow the pavement edge, effectively narrowing the usable surface. Soil treatments that are commonly used under new roadbeds are sometimes ignored on trail projects; as a result, the surfaces are shortly destroyed by intruding plants.

## SOLUTION OVERVIEW

For the most part, satisfying bicycling maintenance requirements is a matter of slightly modifying current procedures. For example, if street

sweeping crews pay a bit more attention to the right edge of the road, it can benefit bicyclists greatly.

In addition, using “maintenance-friendly” design and construction techniques can reduce the need for special—and sometimes costly—treatments later. For example, when paving a street bordered by unpaved alleys and driveways, paving into those alleys and driveways 3 m to 6.1 m (10 ft to 20 ft) (depending on grades and other features) can keep entering traffic from dragging gravel and other debris onto the paved surface.

Finally, special bicycle facilities like bike lanes or trails may require enhanced maintenance attention. This cost, along with a clear understanding of who has responsibility for maintenance, should be part of every project budget.

## OBJECTIVES

1. To maintain roadways and bikeways to a relatively “hazard free” standard:
  - By sweeping pavement edges and paved shoulders with sufficient care.
  - By patching surfaces as smoothly as possible and by requiring other agencies or private companies to do likewise whenever they dig up a road or trail.
  - By making sure pavement overlay projects feather the new surface into the existing one or otherwise do not create new linear joints.
  - By replacing such hazards as dangerous grates or utility covers as the opportunity arises.
  - By patching potholes in an expeditious manner.
  - By routinely cutting back all encroaching vegetation, especially on trails or popular bike routes.
2. To encourage bicyclists to report maintenance problems and other hazards:
  - By developing a “bicycle spot improvement” form and distributing copies throughout the bicycling community.
  - By making sure returned forms are acted upon in a timely fashion.
3. To design and build new roadways and bikeways in such a way as to reduce the potential for maintenance problems in the long term:
  - By using edge treatments, shoulder surfaces, and access controls that reduce the potential accumulation of debris.
  - By using materials and construction techniques that increase the longevity of new trail surfaces.
4. To include maintenance costs and clearly spelled-out maintenance procedures in all bicycle facility projects:
  - By including reasonable estimates of the maintenance costs in the project’s budget.
  - By establishing clear maintenance responsibilities in advance of construction.

## IMPLEMENTATION STRATEGIES

Improving bicycle-related maintenance requires action on several fronts. First, maintenance policies used by all relevant agencies should be reviewed and changed, if necessary. Second, designers should be encouraged to “think maintenance” when they design; low maintenance requirements should be the rule rather than the exception. And, finally, an outreach effort should be implemented to 1) encourage bicyclists to report maintenance problems; and 2) identify existing maintenance problems, particularly on special bicycle facilities or popular bicycling routes.

## SUBTASKS

### 1. Identify key implementors

Implementation requires working closely with those agencies and personnel responsible for maintaining the current infrastructure, as well as those charged with designing and building new facilities. For roadway maintenance, this may mean the local street department or the State transportation agency’s district maintenance division. For trails, it may mean local, State, or Federal parks or lands agencies.

New facility design can involve local engineering and parks planning agencies, as well as State and Federal officials, depending on jurisdiction. It may be, for example, that a new arterial street being built in the local community is actually designed by engineers working in the State capital.

### 2. Review existing policies and practices

In some cases, an agency’s policies, standards, and guidance are included in formal documents that have gone through an approval process or that have been issued by department supervisors. Examples of these may be standard sweeping schedules and snow removal street priorities. Conducting a review of these may be relatively simple once copies have been obtained.

On the other hand, some practices may simply be matters of how a particular person handles a specific task. For instance, one street sweeper may leave more of the right roadway edge unswept than another sweeper may. Identifying important areas in which practices vary from standard procedure—or in which standard procedures do not exist—can help in determining needed improvements in such areas as policy development, communication, and employee training.

### 3. Review results in the field and solicit comments from users

In some cases, policies may seem reasonable, in theory, but may break down in practice. For this reason, it is important to see how well the facilities work. Checking out the street and trail systems from the saddle of a bicycle can help uncover previously unknown problems. For instance, an agency may have a policy of sweeping arterial streets every two weeks. But field experience may show that certain arterials are subject to greater accumulations of debris from nearby land uses. Increasing the frequency of sweeping on such streets—particularly if they are popular bicycling streets—may be necessary.

In addition, soliciting comments from users can help identify problems that would otherwise be overlooked. Because of their intimate knowledge of

surface conditions, bicycle users can often pinpoint specific locations and needs. To get such information, send news releases to local bicycle groups, as well as the media asking for help. In all likelihood, users will welcome the opportunity to contribute.

#### 4. Recommend appropriate changes in policies and practices

Based on the reviews and comments discussed above, develop modified versions of policies and practices where warranted; for important topics previously not covered, develop new guidance for adoption. Work with the appropriate agencies to make sure the changes are understood and implemented.

#### 5. Create an on-going spot improvement program

As mentioned earlier, soliciting comments from users can help an agency find specific problem locations. Institutionalizing this process, in the form of a “spot improvement program,” can provide on-going input and, in many cases, help identify problems before someone gets hurt. In addition, such a program can dramatically improve the relationship between an agency and the bicycling public. Spot improvement programs are good policy and good public relations.

To this end, set aside a modest annual budgetary allocation for user-requested spot improvements. Create mail-back postcards for distribution to local bicycle shops and user groups. As cards come in, check out the locations identified and take action as necessary.

#### 6. Evaluate progress

As the work proceeds, keep track of successes and failures, as well as the schedule of routine maintenance activities. Identify changes that have or have not been made to policies and determine if additional effort is needed. On an annual basis, ask the bicycling public for comments on maintenance issues, in general, and the spot improvement program, in particular. In addition, keep track of the numbers and kinds of problems identified and how they were dealt with. Finally, determine if the program budget is appropriate to the task.

## RESOURCE REQUIREMENTS

For the most part, bicycle-related maintenance tasks involve work an agency already does; little additional effort will be required. It may simply mean adding popular bicycling routes to the priority sweeping route network, for example. In some instances, however, additional equipment may be needed. For example, maintaining a particular trail may require purchasing special equipment—perhaps a small sweeper or a special attachment for a tractor.

## SCHEDULE

In regions with harsh winters, special effort should be made to clear the winter’s accumulation of road sand and other debris early in the spring. Also, the periods following high winds and flooding may require special attention.



*Attention should be paid and repairs should be made to surface irregularities that occur where bicyclists are expected.*

## SPECIFICATIONS

### Typical maintenance concerns

The following are some of bicyclists' most common maintenance concerns and some common solutions:

#### Surface problems:

***Potholes and other surface irregularities:*** Patch to a high standard, paying particular attention to problems near bicyclists' typical travel alignments. Require other agencies and companies to patch to a similarly high standard; if repairs fail within a year, require remedial action.

***Debris (sand, gravel, glass, auto parts, etc.) near the right edge of the road:*** Sweep close to the right edge. If necessary, use vacuum trucks to remove material, especially if it accumulates adjacent to curbs. Pay particular attention to locations like underpasses where changes in lighting conditions can blind bicyclists to surface hazards.

***Debris or surface irregularities on curves or at intersections:*** Pay special attention to the areas between the typical paths of turning and through motor vehicle traffic; often these fill with debris and are in typical bicyclist trajectories. In addition, areas where debris washes across the paved surface should receive special attention; eliminating the source of the problem, by, for example, providing better drainage, is ultimately a more cost-effective solution than increased sweeping.

***Chip seal gravel:*** Many local agencies use chip seal to extend the lives of their roadways. However, the technique, which involves laying down a coating of oil and a layer of crushed rock, often leaves deep piles of gravel just to the right of the typical travel paths of motor vehicles. To reduce the impacts on bicyclists, remove excess gravel as soon as possible and suggest alternate routes as detours.



**Ridges or cracks:** These should be filled or ground down as needed to reduce the chance of a bicyclist catching a front wheel and crashing. Pay particular attention to ridges or cracks that run parallel to the direction of travel. One common location to check is where a merging lane is provided just beyond an intersection. Because traffic must merge left to continue travelling straight, bicyclists will be crossing the joint between the merge lane and the through lane at a very shallow angle.

### Encroaching vegetation:

**Bushes and tree branches adjacent to trail edges:** Trim vegetation back to allow at least a 0.6-m (2-ft) clearance between the edge of pavement and the vegetation, paying particular attention to the insides of curves.

**Grasses adjacent to trail edges:** Tall grasses should be mowed regularly to expose any potential hazards that might otherwise be hidden from a cyclist's view. In addition, vegetation should be prevented from breaking up the edge of pavement and encroaching on the trail surface.

### Signing and marking:

**Trail signing:** Because they are often unique, trail signs may be subject to frequent theft or vandalism. Regular inspections should be conducted to ensure that signs are still in place and in good condition; this is particularly true of regulatory signs and warning signs.

**Trail markings:** Generally, trails have a few simple markings (e.g., a yellow centerline) but these should be repainted when necessary. Centerlines, for example, help encourage bicyclists to keep to their side of the trail and perform a very useful function.

**On-road bicycle signs:** Special bicycle signs (regulatory, warning, or information) should be maintained in the same way that other roadway signs are. Pay particular attention to bike route signs at decision points, warning signs at special hazard locations, and regulatory signs on popular bike lane streets.

**On-road bicycle markings:** Bicycle lane striping should be renewed at the same time as other lane stripes are painted. The same goes for bike lane pavement markings (e.g., bicycle symbol markings). Some markings may suffer from more wear and tear than others and deserve special attention. For instance, pavement markings that indicate the "hot spot" for traffic signal loop detectors may be in the location where car tires routinely pass; as a result, they may wear out faster than other markings.

## REFERENCES

- Maintenance Manual*, AASHTO, 1987  
*Guide for the Development of Bicycle Facilities*, AASHTO, 1998 (pending)  
*Trails for the 21st Century*, Rails to Trails Conservancy, 1994

## CONCLUSION: START WHERE YOU CAN



Photo: James Mackay, Denver Bike Planner

### ...BUT GET STARTED!

The previous sections describe some of the basic improvements that can help improve any community's conditions for its bicycling public. As mentioned in the introduction, each project and program can be seen as part of a larger comprehensive planning effort. But, since money is often scarce, each can also be implemented singly with gratifying results. And implementation can be accomplished in phases that best reflect local realities. The authors hope that this manual provides equal measures of inspiration and nuts-and-bolts details to encourage you to move your community forward to a more "bicycle-friendly" future.

