



University of Massachusetts  
Transportation Center

# AN EVALUATION OF TECHNOLOGIES FOR AUTOMATED DETECTION AND CLASSIFICATION OF PEDESTRIANS AND BICYCLISTS



Jane Swift  
*Governor*

James Scanlon  
*Secretary*

John Cogliano  
*Commissioner*

## Technical Report Document Page

1. Report No.	2. Report Date May 20, 2002	
3. Title and Subtitle An Evaluation of Technologies for Automated Detection and Classification of Pedestrians and Bicyclists	4. Author(s) David A. Noyce and Raghuram Dharmaraju	
5. Performing Organization Name and Address University of Massachusetts Transportation Center 214 Marston Hall Amherst, MA 01003	6. Performing Organization Report No.	
7. Sponsoring Agency Name and Address Massachusetts Highway Department Ten Park Plaza Boston, MA 02116	8. Type of Report and Period Covered Final Research Report 5/1/01 to 6/30/02	
9. Supplementary Notes Prepared in cooperation with the Massachusetts Highway Department and the Federal Highway Administration		
<p>10. Abstract</p> <p>A study of automated detection technologies was undertaken as part of the Massachusetts Highway Department (MassHighway) Research Program. The objective of this research was to identify and evaluate existing technologies that may accurately and efficiently detect, count, and classify non-motorized modes of transportation (i.e., pedestrians and bicyclists). In addition to accuracy and efficiency, other critical criteria considered included: applicability to both on-road and off-road locations; flexibility in detecting and classifying non-motorized activity under multiple conditions; portability; and cost effectiveness.</p> <p>The research process began by identifying detection technologies currently used in the transportation industry. Microwave, ultrasonic, acoustic, video image processing, piezoelectric, passive infrared, active infrared, magnetic, and traditional (inductive loops and pneumatic traffic classifiers) were considered. The research team selected active infrared for further analysis. An Autosense II Active Infrared Imaging Sensor was purchased and evaluated.</p> <p>The experiment was conducted during the summer and fall of 2001. The Autosense II device was frame-mounted 18 feet above the selected observation location and connected to a desktop computer. Data consisted of the manually collected trail user volumes, separated into pedestrian and bicyclists volumes, and the detection and classification data from Autosense II. The data obtained from Autosense II were compared with the manual counts to evaluate the performance of the device in detection and classification.</p> <p>The results showed that Autosense II was very effective in both detection and classification of bicyclists and the detection of pedestrians. Ninety-seven percent of the bicyclists observed were accurately detected. Classification of bicyclists was less accurate as only 77 percent of the bicyclists detected were classified (as motorcycles). Ninety-two percent of pedestrians observed were successfully detected; however, no pedestrians were classified correctly since the algorithms were not designed for this function. Nevertheless, nearly all observations classified as "unknown" were pedestrians. The results of this research indicate that none of the market-available ITS devices are effective at both pedestrian and bicyclist detection and classification. Nevertheless, active infrared is a technology with the capability of pedestrian and bicycle detection and classification with some modifications.</p>		
11. Key Words Pedestrian, Bicycle, ITS, Active Infrared, Detection	12. Distribution Statement Unrestricted	
13. Security Classif. (of this report) Unclassified	14. Security Classif. (of this page) Unclassified	15. No. of Pages 58

**AN EVALUATION OF TECHNOLOGIES  
FOR AUTOMATED DETECTION AND CLASSIFICATION  
OF PEDESTRIANS AND BICYCLISTS**

**Final Project Report**

By

**David A. Noyce, Ph.D., P.E.**  
Principal Investigator

and

**Raghuram Dharmaraju**  
Research Assistant

University of Massachusetts – Amherst  
214C Marston Hall  
Amherst, MA 01003  
Phone: (413) 545-2509  
Fax: (413) 545-9569



May 20, 2002

---

## **DISCLAIMER**

---

The contents of this report reflect the views of the authors, who are responsible for the facts and the accuracy of the data presented herein. The contents do not necessarily reflect the view or policies of the Massachusetts Highway Department or the Federal Highway Administration. The report does not constitute a standard, specification, or regulation.

---

## EXECUTIVE SUMMARY

---

A study of automated detection technologies was undertaken as part of the Massachusetts Highway Department (MassHighway) Research Program. This program is funded with Federal Highway Administration (FHWA) Statewide Planning and Research (SPR) funds. Applied research is conducted on topics of importance to MassHighway.

The objective of this research was to identify and evaluate existing technologies that may accurately and efficiently detect, count, and classify non-motorized modes of transportation (i.e., pedestrians and bicyclists). In addition to accuracy and efficiency, other critical criteria considered included: applicability to both on-road and off-road locations; flexibility in detecting and classifying non-motorized activity under multiple conditions; portability; and cost effectiveness.

A wide variety of automated detection technologies have emerged in recent years due to advances in science and technology. Vehicles have remained the primary focus of automated detection technologies, with limited applications for non-motorized transportation. Few applications have developed for pedestrian and bicycle detection and no efficient methods currently exist for pedestrian and bicycle classification. The effectiveness of Intelligent Transportation Systems (ITS) technologies in automating the collection of both non-motorized volume and classification data has not been widely researched.

The first step in this research process was to identify and investigate detection technologies currently used in the transportation industry. Technologies identified include microwave, ultrasonic, acoustic, video image processing, piezoelectric, passive infrared, active infrared, magnetic, and traditional (inductive loops and pneumatic traffic classifiers). The research team identified active infrared and video image processing as promising technologies and selected active infrared for further analysis. An Autosense II Active Infrared Imaging Sensor was purchased and evaluated.

Autosense II had a number of perceived advantages. It appeared to be easy to install/uninstall and was easily portable. It did not require special technical support and did not require staff beyond installing and uninstalling the equipment on site. Added to these advantages, Autosense II was currently capable of classifying motorcycles, a reasonable surrogate for bicycles. Therefore, Autosense II appeared closer to the pedestrian/bicycle market than video image processing.

Since the primary objective of the experiment was to evaluate the accuracy with which Autosense II could detect and classify pedestrians and bicyclists, the first step in the experimental design was to define what constitutes correct and incorrect responses. A correct response was considered a detection supported by an accurate classification. Since Autosense II was programmed to classify only motorcycles, vehicles, and trucks, bicycles classified as motorcycles were considered a correct response. The percentages of correct responses estimated throughout the experiment represented the statistical accuracy of the device for both detection and classification of pedestrians and bicyclists.

The Autosense II device was frame mounted 18 feet directly above the selected observation location. An AC power source was required, obtained from an existing building close to the site, using heavy-duty outdoor power cables. A desktop computer placed on a portable table near the study site supported the computing needs of the device.

Experiments were conducted on random days during the summer and fall of 2001. Data consisted of the manually collected trail user volumes, separated into pedestrian and bicycle volumes, and the detection and classification data from Autosense II. Data obtained from Autosense II were compared with the manual counts to evaluate the performance of the device in detection and classification.

Experimental results found that Autosense II was very effective in both detection and classification of bicyclists and the detection of pedestrians. Ninety-seven percent of the bicyclists observed were accurately detected. Classification of bicycles was less accurate, as only 77 percent of the bicyclists detected were correctly classified (as motorcycles). Ninety-two percent of pedestrians observed were successfully detected. As expected, no pedestrians were correctly classified since the Autosense II internal algorithms were not designed for this classification type. Nevertheless, nearly all observations classified as “unknown” were pedestrians. Apart from the quantitative results of the percentage of correct and incorrect results, general observations were made throughout the experiments to comprehend the operation of the operating algorithms and diagnose the results obtained. Additionally, a qualitative evaluation was completed to determine the potential of Autosense II ultimately meeting the research objectives.

The results of this research show that none of the market-available ITS devices, in their current form, are effective at both detection and classification. Nevertheless, active infrared and video image processing are technologies with the capability of pedestrian and bicycle detection and classification with some modifications.

Several points can be made regarding the Autosense II active infrared device. First, when a pedestrian and bicyclist passed under the device simultaneously, they were often classified incorrectly. Though this does pose a classification problem, it is believed that such instances can be classified correctly using the false color image data produced. Second, there are a variety of trail users, each with unique characteristics. It may not be possible to identify each of these users, but detection and general classification appear possible. Finally, the active infrared device was not labor intensive, requiring less than 30 minutes for either installation or removal. Two people were required for installing the device along with an appropriate mounting source and power supply. The active infrared device was not sensitive under general light and weather conditions. Reliability appeared to be excellent.

The authors recommend that additional research be conducted to better understand the underlying algorithms used in active infrared applications and to make the changes recommended. Autosense II technology may be successfully modified to obtain accurate detection and classification of pedestrians and bicycles and assist in reliable and widespread data collection. Additional research on the detection algorithms was being conducted at the University of Massachusetts at the time this report was written.

---

## TABLE OF CONTENTS

---

	<b>Page</b>
EXECUTIVE SUMMARY .....	v
LIST OF FIGURES .....	ix
LIST OF TABLES .....	x
CHAPTER 1 - ITS TECHNOLOGY APPLICATIONS TO PEDESTRIANS AND BICYCLISTS .	1
Introduction.....	1
Importance of Non-Motorized Modes of Transportation.....	1
Massachusetts Pedestrian and Bicycle Plans .....	2
Data Needs.....	2
Problem Statement.....	3
Research Objectives .....	5
Scope.....	5
Report Outline .....	5
CHAPTER 2 - DETECTION TECHNOLOGIES IN TRANSPORTATION .....	6
Identified Technologies .....	6
Microwave Radar .....	6
Applications and Limitations.....	8
Ultrasonic.....	9
Applications and Limitations.....	10
Acoustic .....	10
Applications and Limitations.....	10
Video Image Processing.....	11
Applications and Limitations.....	12
Passive Infrared .....	12
Applications and Limitations.....	13
Active Infrared.....	14
Applications and Limitations.....	15
Piezoelectric .....	16
Applications and Limitations.....	16
Magnetic Sensors .....	16
Applications and Limitations.....	17
Traditional .....	17
Applications and Limitations.....	17
Suitable Technologies .....	17
Final Selection .....	19
CHAPTER 3 - ACTIVE INFRARED TECHNOLOGY.....	20
Autosense II .....	20
Operation of Autosense II .....	20
Geometry of Autosense II .....	21
Process of Detection and Classification.....	23

CHAPTER 4 - DESIGN AND SETUP OF FIELD EXPERIMENT ..... 25

- Experimental Design ..... 25
  - Definitions of Observations ..... 25
  - Number of Observations ..... 25
  - Site Selection ..... 26
  - Experimental Setup ..... 28
  - Data Collection ..... 29

CHAPTER 5 - ANALYSES AND RESULTS ..... 30

- Analysis of Observations ..... 30
  - Bicycle Detection and Classification ..... 31
  - Pedestrian Detection and Classification ..... 35
  - Effect of Environmental Factors ..... 38

CHAPTER 6 - CONCLUSIONS AND RECOMMENDATIONS ..... 39

- Active Infrared ..... 39
  - Recommendations for Changes in Hardware ..... 39
  - Recommendations for Changes in Software ..... 39
  - Recommendations Regarding Data ..... 40
  - Other Findings ..... 41
  - Recommendations for Future Research ..... 41

REFERENCES ..... 42

APPENDIX A – Detection and Classification Data Sheet Example ..... 43

APPENDIX B – Text Data File Example ..... 45



---

## LIST OF FIGURES

---

Figure	Page
Figure 1. Microwave Detection.....	7
Figure 2. Two-Segment FMCW Waveform and Defining Parameters.....	7
Figure 3. Doppler Shift in Frequencies.....	9
Figure 4. Video Image Processing.....	11
Figure 5. Passive Infrared Detection.....	13
Figure 6. Multiple Passive Infrared Detection Zones.....	14
Figure 7. Beam Geometry.....	15
Figure 8. Image Produced by an Active Infrared Detector.....	16
Figure 9. Setup of Autosense II - Schematic Representation.....	20
Figure 10. Steps Involved in Classification.....	21
Figure 11. Overhead Active Infrared Device.....	22
Figure 12. Geometry of Autosense II.....	22
Figure 13. Plan of Laser Beams on Path Surface.....	23
Figure 14. Autosense II.....	23
Figure 15. Norwottuck Rail Trail.....	27
Figure 16. Norwottuck Rail Trail under Route 116 in Amherst, MA.....	28
Figure 17. Sample False Color Image of a Bicyclist.....	31
Figure 18. Bicycle Entering Beam 1.....	32
Figure 19. Bicycle enters Beam 2.....	33
Figure 20. Bicycle leaves Beam 1.....	33
Figure 21. Bicycle leaves Beam 2.....	34
Figure 22. False Color Image of a Pedestrian.....	35
Figure 23. Pedestrian's Hand Cuts Beam 1.....	36
Figure 24. Hand Swings Back, and a Leg Cuts Beam 1 Resulting in Multiple Detections.....	36
Figure 25. Pedestrian Moves out of Beam 1 and Cuts Beam 2.....	37
Figure 26. Multiple Detections are Produced as Pedestrian Exits Beam 2.....	37
Figure 27. False Color Image of a Pedestrian.....	40
Figure 28. False Color Image of a Bicyclist.....	40

---

## LIST OF TABLES

---

<b>Table</b>	<b>Page</b>
Table 1. Assessment of Data Priorities (1).....	4
Table 2. Comparison of Automated Detection Technologies.....	18
Table 3. Definitions of Correct and Incorrect Responses .....	25
Table 4. Results of Field Experiments .....	30

---

## CHAPTER 1

# ITS TECHNOLOGY APPLICATIONS TO PEDESTRIANS AND BICYCLISTS

---

A study of automated detection technologies was undertaken as part of the Massachusetts Highway Department (MassHighway) Research Program. This program is funded with Federal Highway Administration (FHWA) Statewide Planning and Research (SPR) funds. Applied research is conducted on topics of importance to MassHighway.

## INTRODUCTION

Over the last decade, the field of transportation engineering has witnessed an enormous increase in the application of modern technologies in the form of Intelligent Transportation Systems (ITS). ITS technologies have significantly improved the efficiency and safety with which transportation systems are built, operated, and maintained. The focus of ITS technology applications has been largely limited to motorized modes of transportation; however, the general capabilities of many ITS technologies suggest that these applications may be effectively extended to non-motorized modes as well. Non-motorized modes of transportation (walking and bicycling) are an integral part of the transportation system and must be accommodated to make the system truly efficient and safe. Traffic engineers often find it easy to underestimate the importance of non-motorized modes and dismiss any efforts to extend ITS technologies in this direction as unnecessary. Current trends in research, planning, and policymaking suggest that this need not be so.

### **Importance of Non-Motorized Modes of Transportation**

Changing perspectives, along with Federal legislation and policies, have led to an increasing recognition of walking and bicycling as viable modes of travel in the local transportation system. This awareness also stems from concerns with the rapidly increasing number of motorized vehicle trips, many of which are local. Most important of these concerns are congestion, safety, and air quality. The potential for pedestrian and bicycle travel to provide mobility, reduce congestion, improve environmental quality, and promote public health has received increasing attention from researchers, planners, and policymakers (1).

The 1994 FHWA *National Bicycling and Walking Study* set a goal of doubling the percentage of trips made by walking and bicycling, while simultaneously reducing the number of pedestrians and bicyclists killed and injured in traffic crashes by 10 percent (2). To date, these goals have not been realized. Reasons for not obtaining these goals are many but are most often attributed to a lack of sufficient infrastructure to safely support non-motorized modes. Absent or narrow bike lanes, high motor vehicle speeds, congestion, and absence of sidewalks cause road users to perceive walking and bicycling as a risk to their safety and therefore avoid these modes of travel.

The need for improved pedestrian and bicycle facilities and for integrating and promoting these facilities in the transportation planning process has been recognized. The 1991 *Intermodal Surface Transportation Efficiency Act* (ISTEA) indicated that improving and sustaining walking and bicycling, either alone or in conjunction with other modes, is a key factor in meeting future air quality goals. Further, the 1998 *Transportation Equity Act for the 21<sup>st</sup> Century* (TEA-21) increased the emphasis of

pedestrian and bicycle considerations in all planning activities. TEA-21 allowed projects that support or improve pedestrian and bicycle travel to be broadly eligible for major funding programs and provided opportunities to compete with other transportation projects for available funding at the State and Metropolitan Planning Organization (MPO) levels (4). Quoting directly from TEA-21 legislation:

- “Bicycles and pedestrians shall be given due consideration in State and MPO long-range transportation plans;”
- “Bicycle and pedestrian projects shall be considered, where appropriate, in conjunction with all new construction and reconstruction of transportation facilities, except where bicycle and pedestrian use is not permitted;”
- “Transportation plans and projects shall provide due consideration for safety and contiguous routes for bicycles and pedestrians.”

In working towards the goals set forth in TEA-21 and the *National Bicycling and Walking Study*, FHWA has been encouraging state and local transportation agencies to think of walking and bicycling as significant modes of transportation and to include them in the overall transportation planning process. As a response, most states have initiated programs to improve pedestrian and bicycling facilities.

### **Massachusetts Pedestrian and Bicycle Plans**

Consistent with federal initiatives, Massachusetts legislation provides that “the (Highway) Commissioner shall make all reasonable provisions for accommodation of bicycle and pedestrian traffic in the planning, design, construction, reconstruction, or maintenance of any project undertaken by the (Massachusetts Highway) Department” (3). With the mission to give pedestrians and bicyclists due importance in the transportation planning process, Massachusetts has prepared statewide comprehensive plans for pedestrian and bicycle transportation. The 1998 *Massachusetts Pedestrian Transportation Plan* and the 1998 *Statewide Bicycle Transportation Plan* set the following goals (3):

- Plan, promote and provide safe travel for pedestrians and bicycles, in a manner appropriate for each group, recognizing that walking and bicycling have distinct operational characteristics and safety requirements;
- Provide pedestrian and bicycle facilities and encourage pedestrian and bicycle travel as viable transportation modes;
- Reduce demands placed on highway facilities by encouraging the use of Transportation Demand Management (management of demand using measures such as toll-ways, HOV lanes, and subsidized transit) and increasing the use of modes such as bicycles.

There are some inherent problems to overcome for these goals to be achieved, the most significant of which may be the lack of relevant data.

### **Data Needs**

Research, planning, and policymaking efforts to improve conditions for pedestrian and bicycle travel require data such as travel and facility characteristics, crash and safety information, and user preferences; however, deficiencies and limitations in existing sources of data often hamper these efforts (1). Understanding trends in walking and bicycling, and forecasting future demand, requires

accurate pedestrian and bicycle travel data. Pedestrian and bicycle activity varies from place to place and depends on many factors, including distances to be traveled, perceived safety, social factors, access and linkage of facilities, terrain, weather, and environmental factors (5). The diversity in the extent of usage of pedestrian and bicycle facilities warrants extensive data collection. Hence, localized data is required to supplement generalized data such as those provided by the U.S. Census (6).

Recognizing the above facts, the Bureau of Transportation Statistics (BTS) completed an assessment of pedestrian and bicycle data needs as an initial step towards filling data gaps and enhancing pedestrian and bicycle data quality. Data needs were identified through published materials and an extensive BTS outreach program involving planners, advocates, and researchers at federal, state, and local government agencies, universities, and nonprofit organizations (1). Table 1 provides a review of five types of pedestrian and bicycle data desired, an estimate of the quality of existing data, and BTS priorities to improve the quality of available data. Only usage, trip, and user characteristics data are relevant to research described in this report; nevertheless, the array of data types and needs highlights the potential benefits of ITS technology. Furthermore, BTS identified data relating to the counting and classification of pedestrians and bicycles by facility or geographic area as a high priority, stressing the need for research to identify technologies to successfully obtain these data.

The BTS report specifically recommended the use of ITS technologies, specifically automated detection technologies, for pedestrian and bicycle data collection (1). Recommendations included: evaluating and promoting new bicycle- and pedestrian-counting technologies (i.e., video imaging, infrared sensors) by synthesizing the results of current pilot-testing efforts, sponsoring additional pilot tests and methodological development, and conducting outreach efforts to disseminate successful technologies. Prior to this study, these recommendations have not led to significant research and development activity.

## **PROBLEM STATEMENT**

A basic underlying concept of the movement toward ITS is that efficiency and safety can be significantly enhanced by providing both the user and operator with better information. Real-time traffic data such as traffic volume, vehicle classification, and speed are examples. ITS applications largely depend on automated detection technologies and have the potential to collect these data more accurately than conventional techniques. Automated detection, counting, and classification can also help overcome the need for extensive staff, time, and effort, generally required for conventional data collection methods.

**Table 1. Assessment of Data Priorities (1)**

<b>Data Type</b>	<b>Description</b>	<b>Primary Uses</b>	<b>Quality of Existing Data</b>	<b>Priority for Better Data</b>
Usage, trip, and user characteristics	Number of bicyclists and pedestrians by facility or area	- Conditions and trend analysis - Network planning - Crash analysis - Demand forecasting	Poor	High
	User and trip characteristics by area or facility	- Conditions and trend analysis - Crash analysis - Demand forecasting	Fair	Medium/High
User preferences	Relative preferences for facility design characteristics and related factors	- Facility design - Network planning - Demand forecasting	Fair	Medium
Facilities data	Characteristics relating to quality of bicycle or pedestrian travel	- Conditions and trend analysis - Facility design - Network planning - Crash analysis	Fair	Medium
Crash and safety data	Specific pedestrian and bicycle variables	- Crash analysis (contributing factors, counter-measures)	Fair	Medium/High
	Non-motor vehicle crash data		Poor	Medium
Secondary data	Safety and demand impacts of design features	- Facility design	Fair	High
	Safety and demand impacts of policies and programs	- Policy and program design	Fair	Medium

A wide variety of automated detection technologies have emerged in recent years due to advances in science and technology. Though many of these technologies evolved through military and defense applications, they have found use in the transportation industry. Vehicles have remained the primary focus of automated detection technologies. Applications for non-motorized transportation modes have so far been limited. Very few applications have developed for pedestrian and bicycle detection and no efficient methods currently exist for pedestrian and bicycle classification. The effectiveness of ITS technologies in automating the collection of non-motorized volume and classification data has not been widely researched.

## **RESEARCH OBJECTIVES**

The primary objective of this research was to identify and evaluate existing technologies that may accurately and efficiently detect, count, and classify non-motorized modes of transportation (i.e., pedestrians and bicyclists). Specific tasks designed to meet this objective included:

1. Identify technologies best suited for automated detection, counting, and classification of non-motorized transportation modes;
2. Determine the feasibility and accuracy of each technology for data collection through field test, and
3. Select one or more promising technologies for future experimentation and application.

In addition to the accuracy and reliability of the data obtained, other critical criteria considered in the selection of technologies included: applicability to both on-road and off-road locations; flexibility in detecting and classifying non-motorized activity under multiple conditions; portability; and cost effectiveness.

## **SCOPE**

The scope of the research focused only on available technologies. Though possibilities of improving or upgrading suitable technologies were explored, implementing significant technology changes was not part of the research.

## **REPORT OUTLINE**

The following chapters in this report describe the background, experimentation, and analysis completed to fulfill the research objectives. Chapter 2 presents a summary of the literature review on available automated detection technologies and their applicability in walking and bicycling. Chapter 3 expands upon a specific technology, active infrared, which was identified as a promising technology worthy of further analysis. Detailed information on active infrared operational characteristics and capabilities is presented. Chapter 4 describes the experimental design used to evaluate the Autosense II active infrared device, including the on-site evaluation procedure. Details of the study site and field conditions are included. Finally, the field observations and experimental results are presented in Chapter 5 along with the research conclusions. Several recommendations for future activities are described.

---

## CHAPTER 2

# DETECTION TECHNOLOGIES IN TRANSPORTATION

---

### IDENTIFIED TECHNOLOGIES

The first step in the research process was to identify ITS technologies used for detection, counting, and classification data collection in the transportation industry. Technologies identified include microwave, ultrasonic, acoustic, video image processing, piezoelectric, passive infrared, active infrared, magnetic, and traditional (inductive loops and pneumatic traffic classifiers). An overview of these technologies and their current applications is presented in the following sections. The advantages and disadvantages of each technology are briefly discussed. All of these technologies are currently used in motorized vehicle detection and classification.

#### **Microwave Radar**

Microwave radar detectors transmit electromagnetic radiation from an antenna towards the area of interest (7). When the vehicle passes through this area, a portion of the transmitted radiation is reflected back to the antenna, causing the object to be detected. The term ‘microwave’ refers to the wavelength of the transmitted electromagnetic radiation, usually between 1 cm and 30 cm (8). This wavelength range corresponds to a frequency range of 1 GHz to 30 GHz, where 1 GHz is equal to  $10^9$  Hz. The term ‘RADAR’ was derived from the functions it performs: Radio Detection and Ranging. The Federal Communications Commission (FCC) limits microwave detectors used for vehicle detection to frequency bands near 10.5, 24.0, and 34.0 GHz. Higher frequencies can illuminate smaller ground areas with a given antenna and thus gather higher resolution data (7, 8).

A schematic diagram of microwave radar detection is shown in Figure 1. A microwave radar unit mounted overhead transmits electromagnetic energy from the antenna toward an area of the roadway. The beamwidth or area in which the radar energy is transmitted depends upon the size and the distribution of energy across the aperture of the antenna (7, 8). Energy constraints are normally established by the manufacturer. When a vehicle passes through the antenna beam, a portion of the transmitted energy is reflected back toward the antenna (8). The energy then enters a receiver to complete the “detection” and vehicle data such as volume, speed, occupancy, and length are calculated.

There are two primary types of microwave detectors (8). The first transmits a continuous wave (CW) of constant frequency. CW waves, when reflected from a moving object, have a different frequency. Frequencies will decrease if a vehicle is moving away from the radar and will increase if a vehicle is moving towards the radar. This change in frequency of the reflected wave is used to calculate the speed of the object using the Doppler principle. Detectors with such capability alone cannot detect motionless objects; however, detectors that are sensitive to very small motions are being developed (7).



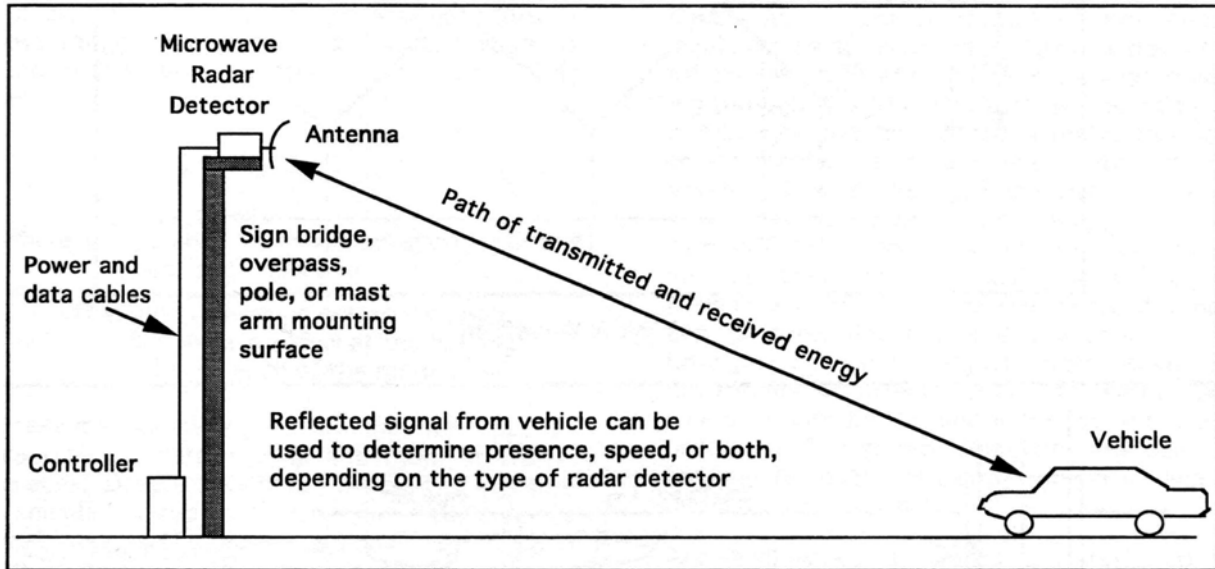

Figure 1. Microwave Detection (8).

The second type of detectors transmit a saw-tooth waveform, also called frequency modulated continuous wave (FMCW), in which the transmitted frequency constantly changes with time (7, 8). FMCW waveform is illustrated in Figure 2. The advantage of the FMCW is it can detect both moving and stationary objects.

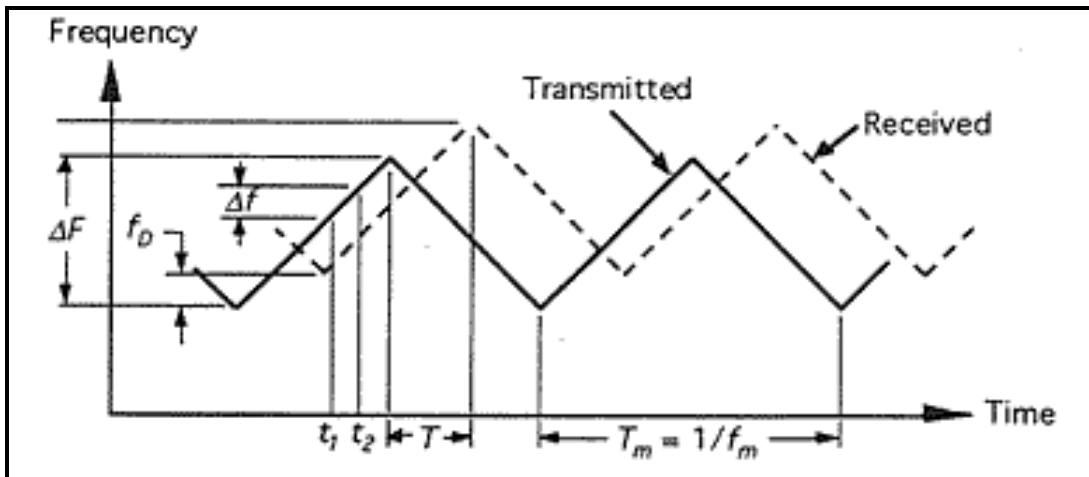

Figure 2. Two-Segment FMCW Waveform and Defining Parameters (8).

Forward-looking FMCW radar measures vehicle speed in a single lane using a 'range binning' technique (8). This technique divides the field of view (in the direction of vehicle travel) into range

bins. A range bin allows the reflected signal to be partitioned and identified from smaller regions on the roadway. Vehicle speed (S) is calculated from the time difference (T) corresponding to the vehicle arriving at the leading edges of two range bins a known distance (d) apart. The vehicle speed is given by:

$$S = d/\Delta T$$

where: S = vehicle speed;

d = distance between leading edges of the two range bins; and

T = time difference corresponding to the vehicle's arrival at leading edge of each range bin.

FMCW radars can also use Doppler principles to calculate moving vehicle speeds (8).

### *Applications and Limitations*

Microwave radar detectors are widely used for vehicle detection and data collection. While some detectors may be mounted over the middle of a single lane to measure approaching or departing traffic flow parameters, some can be mounted on the side of a roadway to measure traffic parameters across several lanes (8). Depending on the beam width or size of the area illuminated by the transmitted electromagnetic energy, forward-looking radar can gather data representative of traffic flow in one direction over a single lane or over multiple lanes. Side-mounted, multiple detection zone radars project the radiation perpendicular to the traffic flow direction and provide data corresponding to several lanes of traffic, but generally not as accurately as the same radar mounted in the forward-looking direction. Side-mounted single detection zone radars are typically used to detect vehicle presence at signalized intersections.

The types of traffic data collected by a microwave radar detector are dependent on the waveform used to transmit the microwave energy. The continuous wave (CW) microwave detectors detect vehicle passage or count by the presence of the Doppler frequency shift created by a moving vehicle, as illustrated in Figure 3 (8). Doppler radars are used to measure vehicular volume and speed on city arterials and freeways. Vehicle presence cannot be measured with the constant frequency waveform, as only moving vehicles are detected.

FMCW presence-measuring radars are used to control left-turn signals, provide real-time volume and occupancy data for traffic adaptive signal systems, monitor traffic queues, and collect occupancy and speed (multizone models only) data in support of freeway incident detection algorithms (8). Multizone microwave presence radars can measure vehicle speed and are gaining acceptance in electronic toll collection and automated truck weighing applications that require vehicle identification based on vehicle length. Side-looking configurations of the FMCW radar give multi-lane coverage. Microwave radar detectors are generally insensitive to weather and operate in night (dark) conditions.

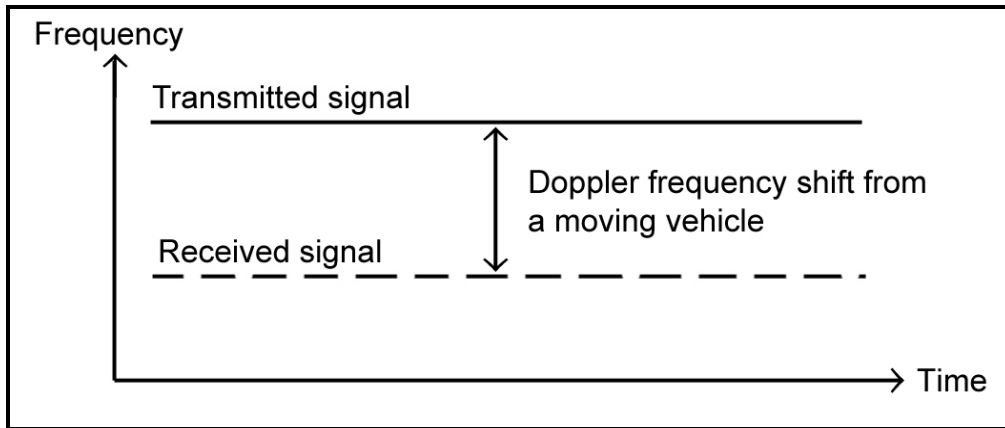

**Figure 3. Doppler Shift in Frequencies.**

Microwave pedestrian detectors have been developed for signal actuation and safety related purposes. Microwave radar technology can be used for vehicle classification using length measurements, but is not very accurate. Owing to non-uniformity in size and shape of the objects of interest, pedestrian and bicycle classification poses more challenges than vehicle classification. Therefore, microwave radar technology is not suitable for classification of pedestrians and bicyclists.

### **Ultrasonic**

Ultrasonic detectors used for passage and presence detection work on the same principle as microwave detectors but use sound waves of selected frequencies instead of microwaves (8, 9). Ultrasonic vehicle detectors can be designed to receive range and Doppler speed data, the same information used by radar detectors. Ultrasonic systems transmit pressure waves of sound energy at a selected frequency above the human audible range, between 20 and 50 KHz, from overhead transducers into an area defined by the transmitter's beam width pattern (8). Pressure waves travel through the air at about 740 mph at sea level. These pulse-shaped pressure waves permit distances to the road surface and vehicle surface to be measured by detecting the portion of energy backscattered or reflected toward the sensor from the area defined (8). The preferred viewing configurations for ultrasonic detectors are either directly downward (i.e., nadir incidence angle) above the vehicle travel lanes or from a horizontally mounted side viewing position.

A typical ultrasonic presence detector transmits ultrasonic energy in the form of pulses. The measurement of the round-trip time it takes a pulse to leave the detector, bounce off a surface, and return to the detector is proportional to the range from the detector to the surface. A detection gate is set to identify the range to the road surface and inhibit a detection signal from the road itself. When a vehicle enters the field of view, the range from the detector to the top of the vehicle is identified, and being less than the range from the detector to the road, causes the detector to produce a vehicle detection signal (7 - 9). Objects less than 0.5 meters above the road surface are not detected.

Pulsed energy transmitted at two known and closely spaced incident angles allows vehicle speed to be calculated by recording the time the vehicle crosses each beam and simply computing a time versus distance calculation (8). The transducers in both the presence and speed-measuring

ultrasonic devices convert the received sonic energy into electrical energy that is fed to signal processing electronics, either collocated with the transducer or located in a roadside controller (8).

### *Applications and Limitations*

Like microwave radar detectors, ultrasonic detectors can be used for both passage and presence detection. Temperature change, air turbulence, and humidity may affect the performance of ultrasonic sensors. These detectors have not been used for vehicle length measurement or classification purposes, though in principle these applications are possible. With the lack of a classification feature, this technology does not appear to be suitable for bicycle and pedestrian classification.

### **Acoustic**

Passive acoustic detectors, which measure sound energy levels, are also used for vehicle detection. Acoustic array sensors measure vehicle passage, presence, and speed by detecting acoustic energy or audible sounds produced by vehicular traffic (8). Sound sources come from within each vehicle and from the interaction of a vehicle's tires with the road. When a vehicle passes through the detection zone, an increase in sound energy is recognized by the signal-processing algorithm and a vehicle presence signal is generated. When the vehicle leaves the detection zone, the sound energy level drops below the detection threshold and the vehicle presence signal is terminated. Response to sounds from locations outside the detection zone are attenuated (7, 8).

Acoustic detectors in transportation engineering detect sounds produced by approaching vehicles with a two-dimensional array of microphones (8). Acoustic sensors detect vehicles by measuring the time delay between the arrival of sound at the upper and lower microphones, which are arranged in a vertical and horizontal line through the center of the diamonded-shape face of the device (aperture). The time delay changes as the vehicle approaches the array. When the vehicle is inside the detection zone (i.e., area on the road pavement designated for vehicle detection by the directional angle of the acoustic aperture), the sound arrives almost instantaneously at the upper and lower microphones. When the vehicle is outside the detection zone, the inter-microphone distance delays sound reception at the upper microphone. The size and shape of the detection zone are determined by the aperture size, processing frequency band and installation geometry of the acoustic array (7, 8). Typical mounting configuration places the aerially-mounted device pointing slightly downward toward the roadway surface (10 to 30 degrees from vertical, depending on mounting height) with a detection range of six to 11 meters.

### *Applications and Limitations*

Acoustic sensors have been used for obtaining volume, lane occupancy and average speed data. Vehicle speed is determined with an internal algorithm that assumes an average vehicle length (7). This assumption may result in inaccurate data, especially when there is a considerable variation in vehicle length.

Acoustic sensors have not been used for vehicle classification. As pedestrians and bicyclists cause very little difference in the sound energy levels, acoustic detectors are neither effective nor suitable for classifying pedestrians and bicyclists.

## Video Image Processing

Video cameras were initially introduced for roadway surveillance and traffic management because of their ability to transmit closed circuit television imagery to a human operator. Present-day traffic management applications use video image processing (VIP) to automatically analyze the scene of interest and extract information for traffic surveillance and control (8). A VIP system typically consists of one or more cameras, a microprocessor-based computer for digitizing, and processing the imagery and software for interpreting the images and converting them into traffic flow data.

VIP systems detect vehicles by analyzing the imagery from a traffic scene to determine changes between successive frames (7, 8). The image processing algorithms that analyze black and white imagery examine the variation of gray levels in groups of pixels contained in the video frames. The algorithms are designed to remove gray level variations in the image background caused by weather conditions, shadows, and daytime or nighttime artifacts and retain objects identified as automobiles, trucks, motorcycles, and bicycles. Traffic flow parameters are calculated by analyzing successive video frames. Color imagery can also be used to obtain traffic flow data allowing enhanced vehicle discrimination under all lighting conditions. However, reduced dynamic range and sensitivity have limited the use of color images. The general processing procedure for VIP is summarized in Figure 4 (8).

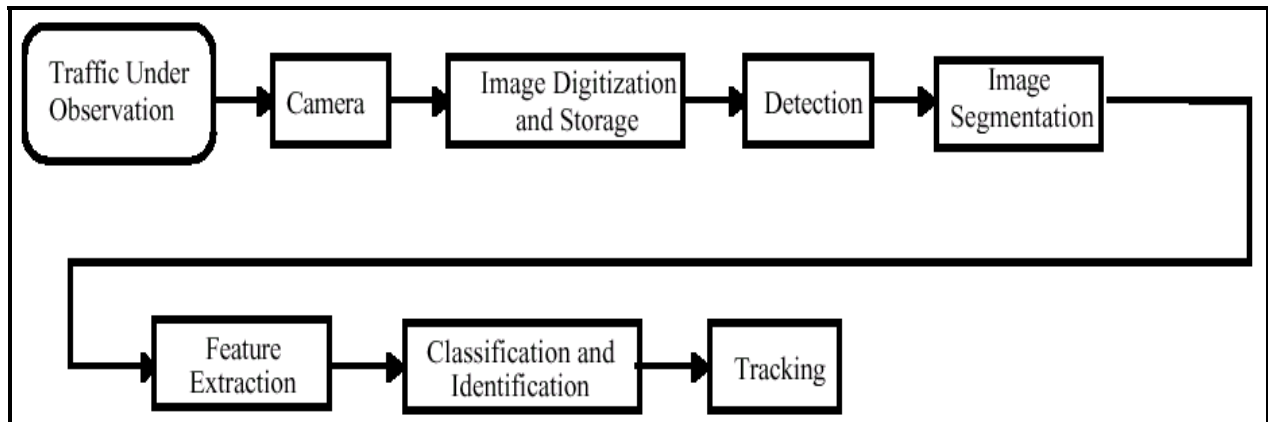

**Figure 4. Video Image Processing (7).**

After the VIP cameras capture an image, the image digitization/storage and segmentation steps are performed, algorithms search the imagery for pre-selected features that enhance detection, classification, and tracking of vehicles. Complex algorithms determine which data are passed to the following step; however, data that are not passed on is lost. Therefore, false vehicle identifications and other “errors” in processing are permitted to pass forward through broadly-spaced thresholds within the early sections of the multi-step algorithm since the declaration of actual vehicles is not made to the conclusion of the detection process. Advances in data reduction and image formatting technologies now allow the algorithms to run in real-time (7, 8).

## *Applications and Limitations*

VIP systems can provide detection of vehicles across several lanes (8). Some VIP systems process data from more than one camera and further expand the area over which data are collected. VIP systems can classify vehicles, and report vehicle presence, flow rate, occupancy, and speed for each class. VIP mounting heights generally vary from 18 to 50 feet above the roadway surface (7). The lower the camera mounting, the greater the error in vehicle speed measurement, as the measurement error is proportional to the vehicle height divided by the camera mounting height.

The use of VIP for bicycle detection is currently being researched (8). Therefore, VIP is a technology that may be used for bicycle detection and classification, and potentially, extended to pedestrian detection and classification given positive research outcomes.

### **Passive Infrared**

Non-imaging passive infrared sensors contain one or several (typically not more than five) energy-sensitive detector elements on the focal plane that gather energy from the entire scene (8). Passive infrared detectors do not emit any energy, unlike active infrared systems discussed in the next section. Passive sensors detect energy that is emitted from vehicles, road surfaces, and objects in a predetermined field of view and from the atmosphere.

Non-imaging detectors have a large instantaneous field of view equal to the angle (e.g. in the x-y plane) subtended by a pixel. Objects within the scene cannot be further divided into sub-objects or pixels (picture elements) with this device. Imaging sensors, such as modern charge-coupled device (CCD) cameras, contain two-dimensional arrays of detectors, each detector having a small instantaneous field of view. The two-dimensional array gathers energy from the scene over an area corresponding to the field of view of the entire array. Imaging sensors display the pixel-resolution details found in the imaged area.

The source of energy detected by passive infrared detectors is gray-body radiation due to the non-zero temperature of the emissive objects. Objects whose temperature is not at absolute zero (-273.15 °C) emit gray-body radiation at all frequencies. Emissivity of an object is defined as the ratio of the actual emitted radiance to that of an ideal blackbody at the same temperature. Hence, if the emissivity of the object is perfect, i.e., emissivity is equal to 1.0, the object is called a blackbody. Most objects have emissivities less than 1.0, termed gray-bodies.

When a vehicle enters the passive infrared device's field of view, the change in emitted/detected energy is used to identify the presence of a vehicle (7, 8). Figure 5 illustrates the principles of this technology. The difference in detected energy created by the vehicle is described by radiative transfer theory (8). The change in emissivities of the vehicle ( $\epsilon_V$ ) and the road surface ( $\epsilon_R$ ) provide the information necessary for the algorithms to identify a detection. Passive sensors can be designed to receive emitted energy at any frequency. Cost considerations make the infrared band a good choice for vehicle detectors with a limited number of pixels. Some detectors that have been developed to operate in the long-wavelength infrared band (8 to 14 micrometers) minimize the effects of sun glint and changing light intensity from cloud movement.

*Applications and Limitations*

Multi-channel and multi-zone passive infrared sensors have been developed to measure speed, vehicle length, volume, and lane occupancy. These devices use four detection zones, for both dynamic and static-thermal energy detection, along the vehicle's path of travel as shown in Figure 6. Time delays between the signals from the three dynamic zones are used to calculate speed. The vehicle presence time from the fourth zone gives occupancy of stationary and moving vehicles.

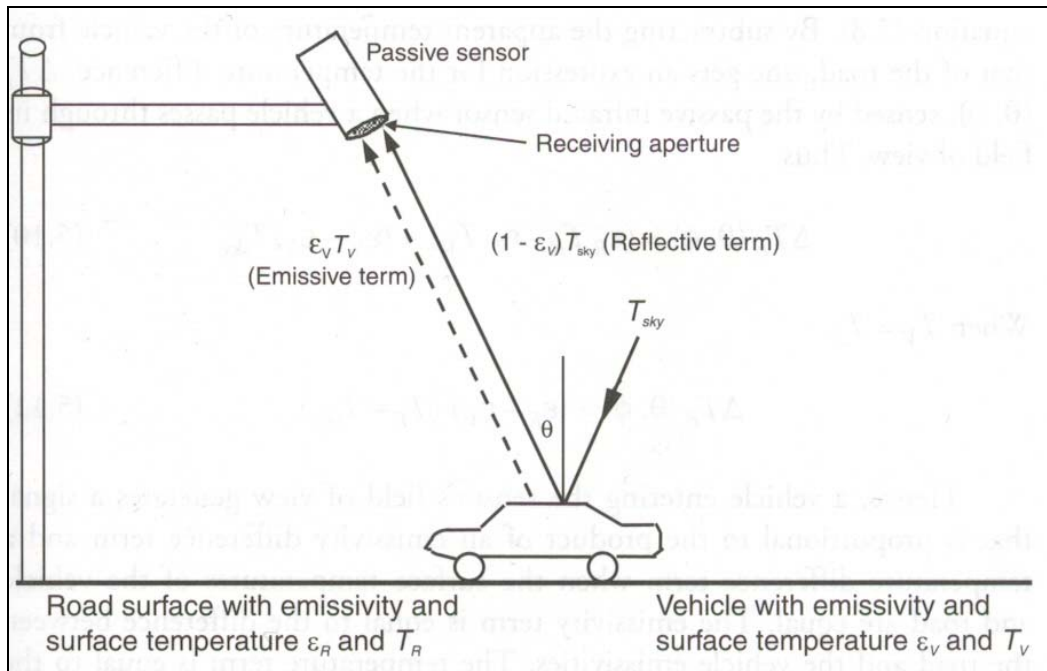

**Figure 5. Passive Infrared Detection (8).**

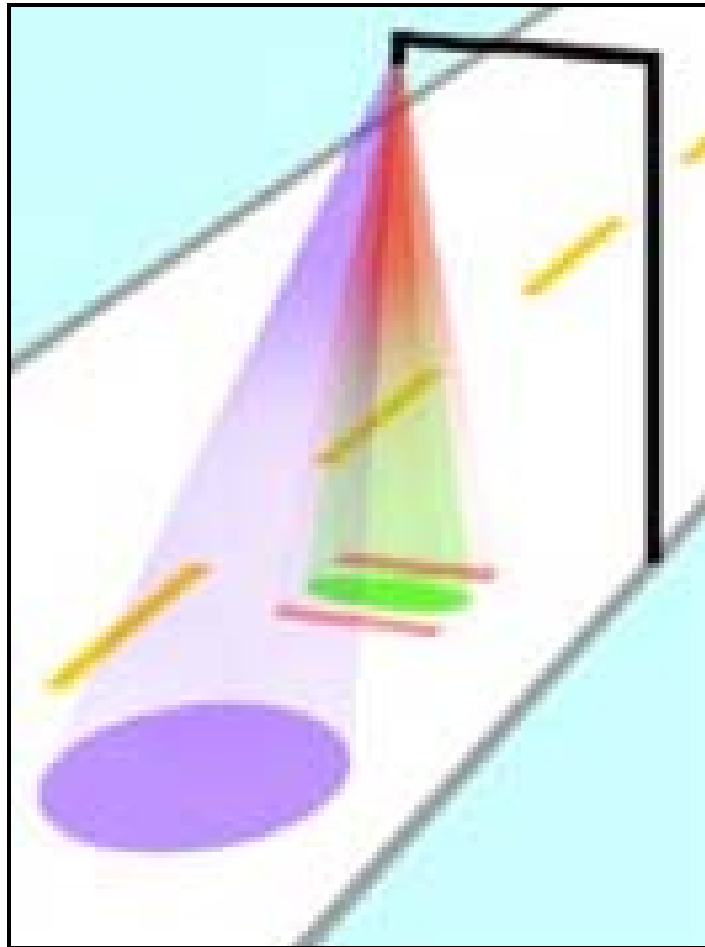

**Figure 6. Multiple Passive Infrared Detection Zones.**

The most significant disadvantage of passive infrared detectors is their potential adverse reaction to weather and light conditions. Atmospheric particulates and inclement weather can scatter or absorb energy that would otherwise reach the focal plane. Scattering and absorption effects are sensitive to water concentrations in fog, haze, rain, and snow as well as to other obscurants such as smoke and dust. At the relatively short operating ranges employed by infrared sensors in traffic management applications, these concerns may not be significant; however, some performance degradation in rain, freezing rain, and snow has been reported. In addition to the problems with weather and light conditions, passive infrared technology is not capable of classification. Therefore, passive infrared technology is not suitable for the detection and classification of pedestrians and bicyclists.

### **Active Infrared**

Active infrared detection zones are illuminated with low power infrared energy laser diodes operating in the near infrared region of the electromagnetic spectrum at 0.85 micrometers (8). The infrared energy reflected from objects moving through the detection zone is focused by an optical system onto an infrared-sensitive detector matrix mounted on the focal plane of the optics. The energy sensitive elements convert the reflected energy into electrical signals.



Active infrared laser sensors have two sets of optics (8). The transmitting optics split the pulsed laser diode output into two beams separated by several degrees as shown in Figure 7. The receiving optics have a wider field of view to receive the energy scattered from vehicles. By transmitting two or more beams, the laser radars measure vehicle speed by recording the times at which the vehicle enters the detection area of each beam. Real-time signal processing is used to analyze the received signals and to determine the presence of the object. Changes in received signal levels caused by environmental effects can be accounted for through signal processing. Additional details of active infrared systems are described in Chapter 3.

### *Applications and Limitations*

Active infrared detectors are currently used to provide vehicle presence, volume, speed measurements, classification, length assessment, and queue measurements. Active infrared devices can be applied in both single lane as well as multi-lane applications. Infrared devices have an additional ability to image the scene of interest allowing it to be used as an alternate method of obtaining imaging data (7, 8). Modern active infrared devices that use laser sensors produce two- and three-dimensional images suitable for vehicle classification.

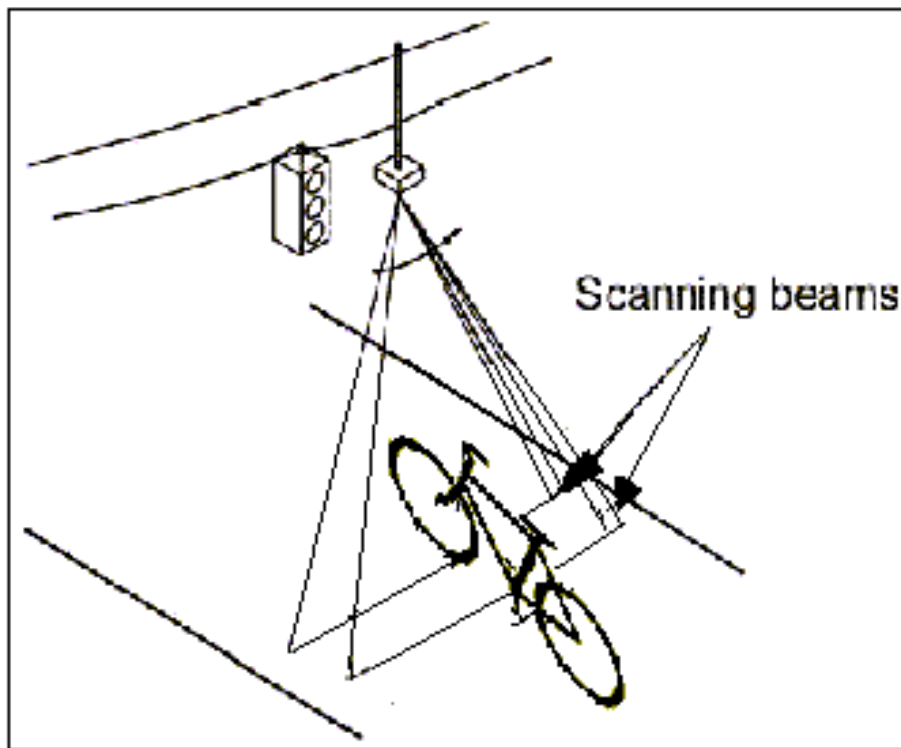

**Figure 7. Beam Geometry (7).**

Figure 8 shows an image of a vehicle with boat in tow produced by an active infrared detector. Images produced from pedestrians and bicyclists can be used for classification purposes. Active

infrared detection may be a technology that can be effectively used in pedestrian and bicycle applications.

### **Piezoelectric**

Piezoelectric detectors consist of paving slabs with a weight sensitive rubber surface incorporating a piezo cable. Piezoelectricity, or “pressure” electricity, is the property of certain materials incorporated in the piezo cable that produce a change in electrical properties with mechanical pressure. The weight of an object on a piezoelectric detector activates the device and sends an electric signal through the piezo cable. Piezos sensitive to weights as small as 5 kg have been developed (10). The characteristics of the electric signal vary depending on the type of the object that passes over. Hence, the objects can be classified on this basis.

#### *Applications and Limitations*

Piezoelectric systems have been used primarily for pedestrian detection and have not been used in bicycle detection or in classification. Theoretically, it may be possible to classify pedestrians and bicyclists using piezoelectric systems, but the accuracy of such applications is unknown. The research team is aware of a proprietary piezoelectric detector developed to identify and classify warehouse vehicles; however, this system is not available on the retail market nor is there available literature. Piezoelectric systems also pose a problem for the purposes of this study since they are not portable and the installation is cumbersome when compared to other ITS technologies. There is no device using piezoelectric technology currently available that can effectively detect and classify pedestrian and bicyclists.

### **Magnetic Sensors**

Magnetic sensors are passive devices, which indicate the presence of a metallic vehicle by detecting the change in the earth’s magnetic field created by the vehicle (8). The distortion and change of the magnetic field with respect to time induces a voltage change that is interpreted by the detector as the passage of a vehicle.

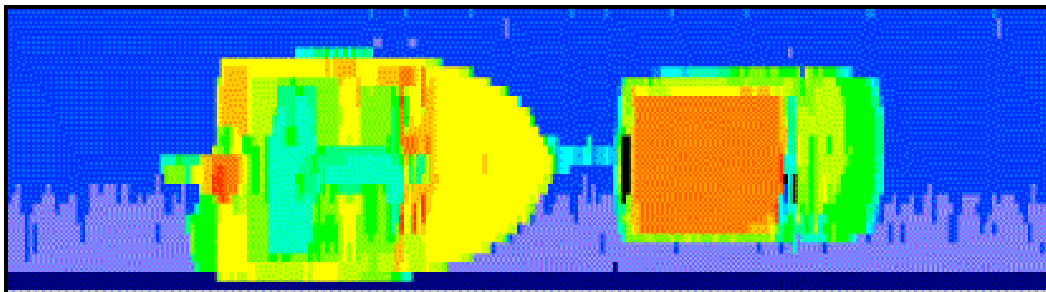

**Figure 8. Image Produced by an Active Infrared Detector (11).**

### *Applications and Limitations*

Magnetic detectors are buried below the pavement surface. These detectors usually require a minimum vehicle speed of three mph for detection (8). Hence, magnetic sensors do not function as presence detectors without multiple units utilizing combined signal processing. The primary problems with magnetic sensors are that installations require pavement cuts, and pedestrians generally do not instigate enough change in the earth's magnetic field to be detected. Additionally, magnetic detectors do not have classification functions. There is no device using magnetic technology currently available that can effectively detect and classify pedestrian and bicyclists.

### **Traditional**

Traditional detection and classification methods use traffic classifiers (pneumatic tubes) and inductive loops. Both of these technologies have been used for many years. Traffic classifiers require placing a hollow rubber tube of approximately 0.5 inches in diameter across the travel path of the vehicle. As a vehicle passes over the tube, the weight of the vehicle compresses the tube and sends an air pulse to the classifier that is detected and processed. Various strategies of tube placements allow for both detection and speed measurements.

Inductive loops consist of several turns of wire imbedded in the pavement surface (8). An electrical current is applied. The wire is connected to a loop detector amplifier that, among other things, detects changes in the loops inductance. As a vehicle passes over the loop, the inductance changes (due to the metal contained within the vehicle). Loop detector amplifiers detect this change and send a detection signal to the appropriate device. A series of loops can be used for passage, presence, and speed measurements.

### *Applications and Limitations*

Neither traffic classifiers nor loop detectors are capable of fully automated detection and classification of both pedestrians and bicyclists. Though inductive loops and tubes may be used to detect and classify bicycles, they cannot be used for pedestrians.

### **SUITABLE TECHNOLOGIES**

In conducting a search for ITS technologies that may be effective in bicycle and pedestrian detection and classification, relevant products were chosen and an assessment of pedestrian and bicycle detection, counting and classification capabilities of the technologies was made. This assessment is summarized in Table 2.

After reviewing each ITS technology previously described, video image processing and active infrared applications had distinct advantages over other technologies because of their imaging capabilities. Thus, video image processing and active infrared technologies appeared worthy of further exploration.

**Table 2. Comparison of Automated Detection Technologies**

<b>Technology, Product Manufacturer</b>	<b>Advantages</b>	<b>Disadvantages</b>	<b>Pedestrian and Bicycle Detection and Classification Potential</b>
<b>Active Infrared</b>  <i>Autosense II</i> Schwartz Electro-Optics, Inc. (11, 12)	<ul style="list-style-type: none"> <li>- Classifies vehicles into eight categories.</li> <li>- Capable of detecting and classifying pedestrians and bicycles.</li> </ul>	<ul style="list-style-type: none"> <li>- Needs to be extended to pedestrians and bicycles.</li> <li>- Performance may be affected by adverse weather.</li> </ul>	High
<b>Video Image Processing</b>  <i>Traffic Vision</i> Nestor Traffic Systems, Inc. (13)	<ul style="list-style-type: none"> <li>- Neural network based technology.</li> <li>- Capable of detecting and classifying pedestrians and bicycles.</li> </ul>	<ul style="list-style-type: none"> <li>- Needs to be extended to bicycles and pedestrians.</li> <li>- Performance affected by adverse weather and darkness.</li> </ul>	High
<b>Microwave Radar</b>  <i>SmartWalk 1400/1800</i> Microwave Sensors, Inc. (14)	<ul style="list-style-type: none"> <li>- Primarily used as pedestrian detection tool at intersections.</li> </ul>	<ul style="list-style-type: none"> <li>- Not designed for classification and counting.</li> </ul>	Low
<b>Piezoelectric</b>  <i>Pedestrian Tactiles</i> Traffic 2000 Ltd. (10)	<ul style="list-style-type: none"> <li>- Tools to differentiate between the characteristic electric signals caused by pedestrians and bicycles can be developed for classification purposes.</li> </ul>	<ul style="list-style-type: none"> <li>- Widespread use for data collection is difficult, as setting up piezos might require excessive effort.</li> </ul>	Low
<b>Passive Infrared</b>  <i>IR 200 Dynamic Detectors</i> ASIM Technologies (15)	<ul style="list-style-type: none"> <li>- Developed for detection applications.</li> </ul>	<ul style="list-style-type: none"> <li>- Classification is not addressed, but possible.</li> <li>- Less effective than active infrared.</li> <li>- Performance affected by adverse weather.</li> </ul>	Medium
<b>Magnetic Sensors</b>	<ul style="list-style-type: none"> <li>- Commonly used device</li> </ul>	<ul style="list-style-type: none"> <li>- Installed in pavement.</li> <li>- Only reacts to items (metals) that alter magnetic field.</li> <li>- Do not detect pedestrians.</li> <li>- Unable to classify.</li> </ul>	Low
<b>Traditional</b>  Traffic Classifiers, Inductive Loops	<ul style="list-style-type: none"> <li>- Combinations of traditional devices may be capable of classification.</li> </ul>	<ul style="list-style-type: none"> <li>- Limitations with respect to mobility, detection and/or classification of users.</li> <li>- No single device is capable of classifying both pedestrians and bicycles.</li> </ul>	Low

## **FINAL SELECTION**

The research team decided to obtain and evaluate only one technology. After carefully reviewing the potential of each technology in pedestrian and bicycle detection and classification it was determined that active infrared technology provided the most promise. Therefore, an Autosense II Active Infrared Imaging Sensor was purchased, evaluated, and tested.

Autosense II had a number of perceived advantages. It appeared easy to install and uninstall. It was easily portable and could be used at multiple sites for widespread data collection efforts. Setting up and taking down the device did not require special technical support from the manufacturer. This mobility, ease of installation, and compatibility with common computers was believed to be beneficial. Data collection using Autosense II did not require staff beyond installing and uninstalling the equipment on site. All the data processing, including classification, was completed simultaneously with the data collection, and no further processing was required to obtain classification results after data collection. Acceptable mounting heights were less than those required for VIP. Autosense II was currently capable of classifying motorcycles, a suitable surrogate for bicycles. As such, the researchers determined it could be extended for bicycle classification with relatively less effort than VIP. Finally, the manufacturer was supportive of this research effort, and offered complimentary technical support throughout the research period.

---

**CHAPTER 3**  
**ACTIVE INFRARED TECHNOLOGY**

---

**AUTOSENSE II**

Autosense II, an active infrared device manufactured by Schwartz Electro-Optics Inc., of Orlando, Florida, was evaluated for its capability to accurately detect and classify non-motorized modes of transportation. The operation of the device is explained in detail in the following sections of this chapter.

**Operation of Autosense II**

Autosense II has the capability for overhead imaging of objects to allow classification and size measurements (11, 12). The device, which can be installed overhead from any suitable support, communicates with supporting algorithms on a local computer. For an accurate understanding of the operation of Autosense II, it is important to be familiar with its general setup. The setup consists of four primary units:

- Autosense II;
- Computer with software;
- Communications system; and
- Power.

A schematic representation of the setup is shown in Figure 9. Autosense II is directly connected to a computer containing the control algorithms and to an AC electrical power source. The device is overhead mounted approximately 20 feet above the detection surface with an incident angle (i.e., forward tilt) of five degrees (8). When an object passes under the overhead mounted Autosense II and interacts with the infrared beam(s), a detection is made and raw detection data is sent to the computer via the communications system. Computer software processes this raw data to classify detections and filter erroneous data. Figure 10 illustrates the series of steps involved in the process before a final classification is made.

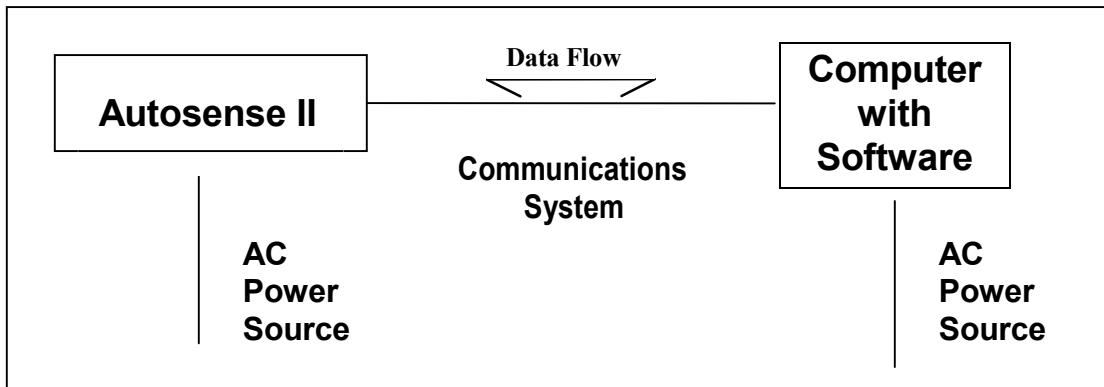

**Figure 9. Setup of Autosense II - Schematic Representation.**

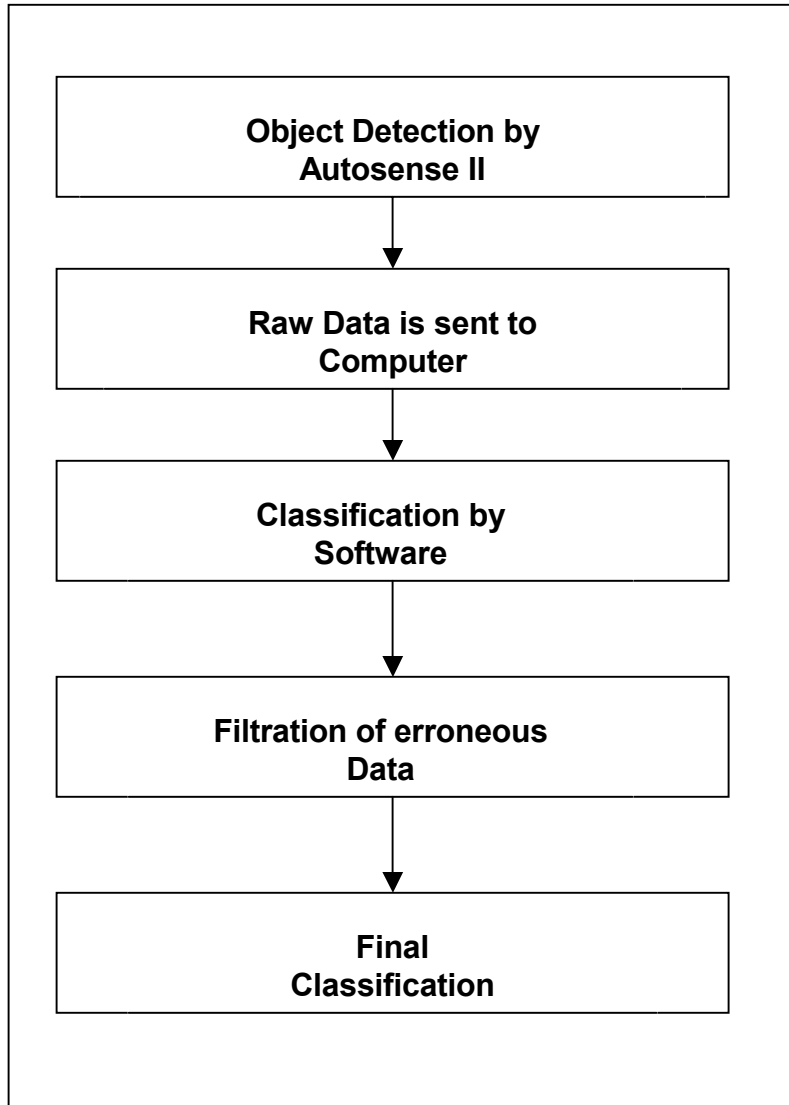

**Figure 10. Steps Involved in Classification.**

### **Geometry of Autosense II**

Autosense II geometry is illustrated in Figures 11 and 12. As previously mentioned, Autosense II is installed overhead at a manufacturer recommended height of between 19 and 23 feet (5.7 – 6.9 m), measured from the point of suspension at the upper end of the device (12). It emits two infrared beams with a separation of 10 degrees. Each beam consists of a series of infrared rays emerging like a flat fan. These rays enable the device to obtain 30 range measurements (height measurements) across the road for each beam. Each beam cuts the road surface in a straight line. The distance between the two beams on the road surface is four feet (1.2 meters) when the device is installed at the manufacturer’s recommended height of 23 feet. These arrays of pixels formed by the rays are shown in Figure 13. A photo of the Autosense II device is presented in Figure 14. Note that the device operates at a scan rate of 720 scans per second.

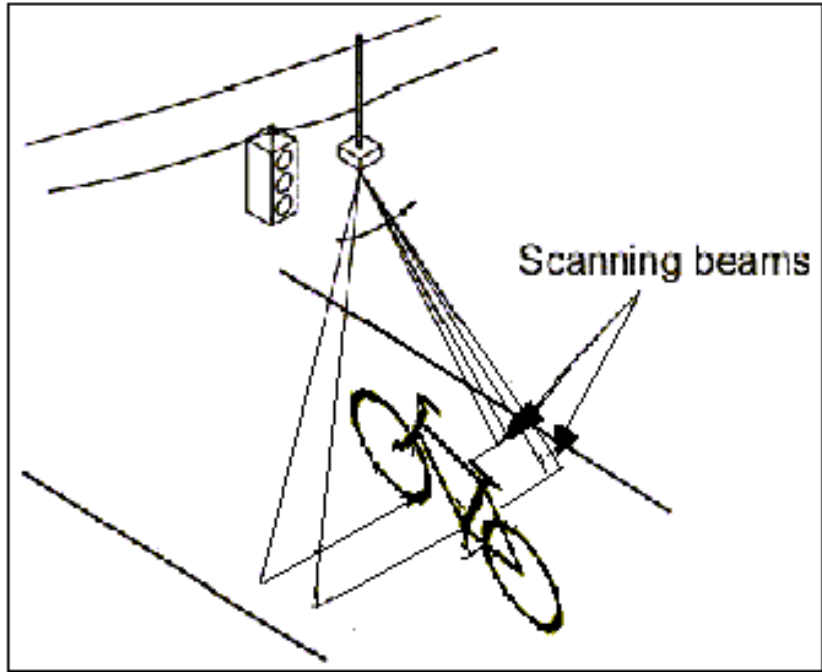

Figure 11. Overhead Active Infrared Device (11).

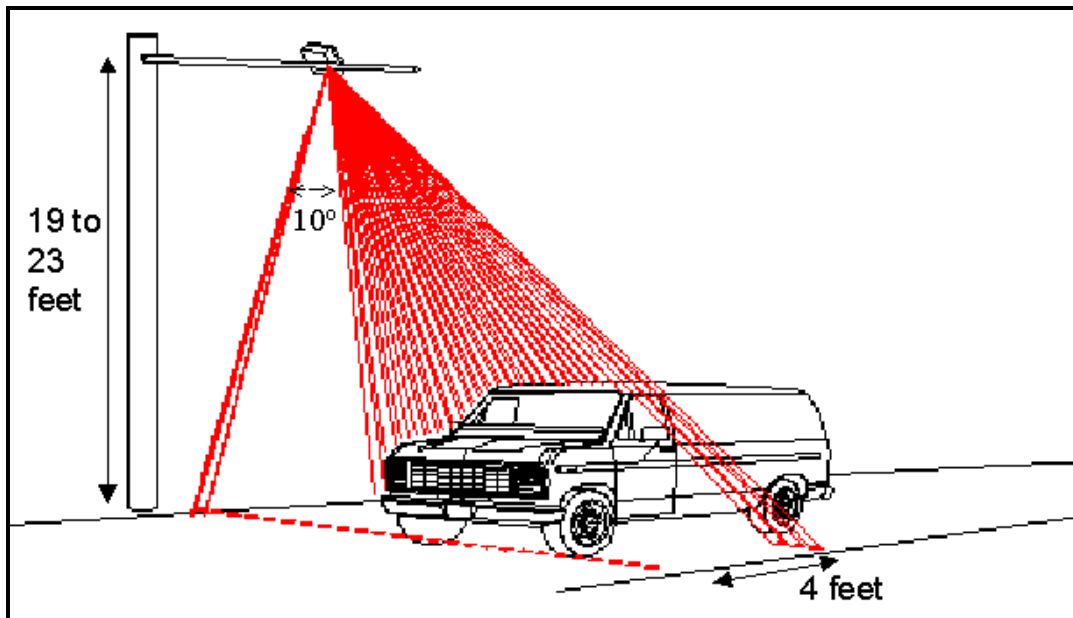

Figure 12. Geometry of Autosense II (11).



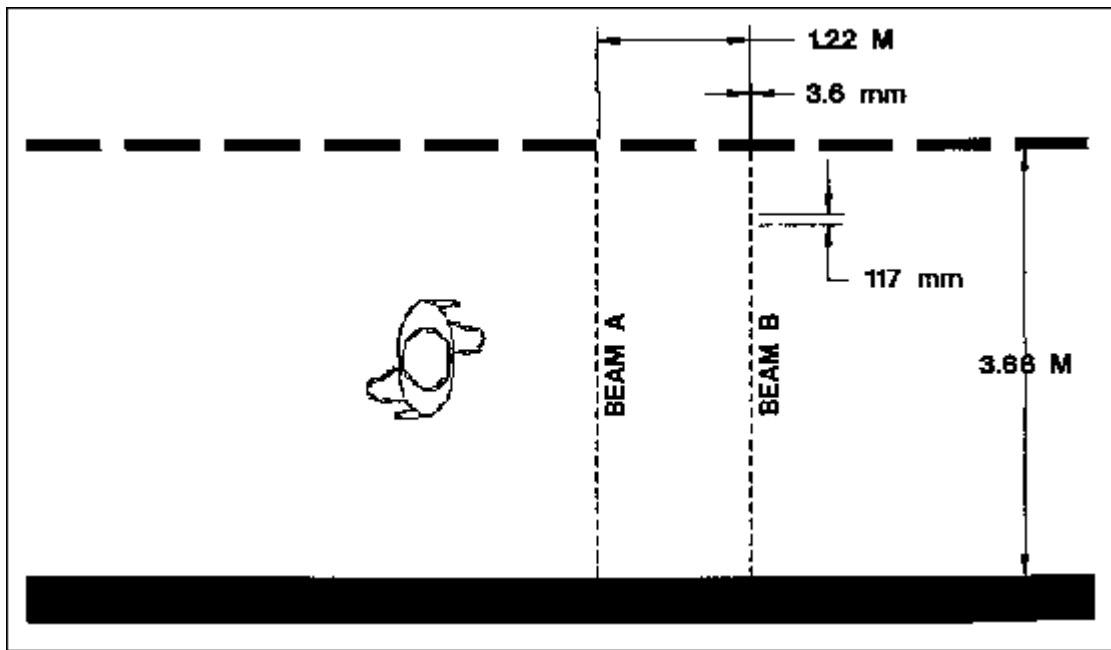

Figure 13. Plan of Laser Beams on Path Surface (11).



Figure 14. Autosense II.

## Process of Detection and Classification

When a vehicle, pedestrian, or bicyclist enters the beam in a designated direction, the measured distance between the device and the detection surface decreases and the corresponding length of each ray is calculated using simple geometry (11, 12). Object height and vertical profile is computed from the (shorter) ray calculation. The width of the object is also calculated by determining the width of the beam's extreme rays that are cut. As the object travels, the second beam is broken in the same manner. Consecutive range samples are analyzed to generate a profile of the object in view.

As mentioned, the distance between the two beams projected on the road surface is four feet (1.2 meters) when the device is installed at the manufacturer's recommended height of 23 feet. Using this distance and the time gap between breaking of the two beams, the velocity of the object is calculated by an internal algorithm. Algorithms also calculate the time the object takes to pass through one beam. The product of time and velocity yields the length of the object. Since the device in its current form was designed for one lane of vehicles in a single direction, algorithms calculate the object's length only when the designated first beam is cut before the second beam and at some point in time both beams are simultaneously cut. Objects passing in the reverse direction are not profiled and classified, though the device will detect the object.

When an object cuts only one of the two beams as it passes under the device, it is detected; however, the algorithm will filter out the detection as erroneous data even after classifying it based on the calculated height, width, and length (if available depending on the direction of movement of the object). Again, programmed detection and classification algorithms required that both beams be simultaneously cut since the device was designed for vehicular data collection only. Any object that is too short to break both beams simultaneously is considered a non-vehicle and therefore the detection is not processed.

Algorithms presently used in the Autosense II software are only capable of classifying motorized vehicles, including trucks, passenger cars, boats and trailers in tow, and motorcycles. With the height, width, and length characteristics of bicycles generally similar to motorcycles dimensions, it was believed that bicycles would be successfully detected and classified as motorcycles. A simple change in the algorithm to output the word "bicycle" instead of "motorcycle" may be the only alteration needed. The design of the Autosense II system and the supporting algorithms left little doubt that a new algorithm and possibly hardware changes/adjustments would be required for accurate pedestrian detection and classification. Few pedestrians would be able to simultaneously encounter both infrared beams at three to four foot spacings.

The next task was to evaluate Autosense II through field experiments. The following chapter describes the experimental design.

---

**CHAPTER 4**  
**DESIGN AND SETUP OF FIELD EXPERIMENT**

---

**EXPERIMENTAL DESIGN**

Based on the overall objective of this research, specific objectives were identified in development of the experimental design including:

- Evaluate the accuracy of the Autosense II active infrared device in classifying pedestrians and bicyclists;
- Understand the operation of active infrared technology and the underlying algorithms used for the purpose of detection and classification of objects that pass under the device;
- Identify the causes behind any deficiencies in the technology; and
- Make appropriate recommendations.

The experiment was designed to assure that each objective was met through proper selection of the three primary experimental decisions, i.e., definition of observations, number of observations, and experiment location. The factors used to make these decisions, and the process involved, are explained in this section.

**Definitions of Observations**

Since the primary objective of the experiment was to evaluate the accuracy with which Autosense II can detect and classify pedestrians and bicycles, the first step in the experimental design was to define what constitutes correct and incorrect responses. Correct and incorrect detection and classification responses were defined as shown in Table 3. The percentages of correct responses estimated through the experiment were used to represent the statistical accuracy of the device for both detection and classification of pedestrians and bicycles. Every correct response was assigned a value of 100 percent and every incorrect response was assigned a value of zero percent.

**Table 3. Definitions of Correct and Incorrect Responses**

<b>Method</b>	<b>Bicycles</b>		<b>Pedestrians</b>	
	<b>Correct</b>	<b>Incorrect</b>	<b>Correct</b>	<b>Incorrect</b>
<b>Detection</b>	The bicycle is detected once.	The bicycle is either not detected or detected more than once.	The pedestrian is detected once.	The pedestrian is either not detected or detected more than once.
<b>Classification</b>	The bicycle is classified as a motorcycle.	The bicycle is not classified as a motorcycle.	No correct response currently exists.	The pedestrian is incorrectly classified.

**Number of Observations**

The duration of the experiment was dependent on the number of observations or data points needed. Standard statistical procedures for determining sample sizes were used to select the minimum number of observations needed in the evaluation of Autosense II. The number of observations to be estimated was based upon the percentage of correct responses, which is equal to the mean of all responses. A common equation used for calculation of sample size ( $N$ ), for one-tailed hypothesis testing and a confidence interval of 95 percent, is (16):

$$N \geq (1.96 \sigma / \delta)^2$$

where:  $\sigma$  = Standard deviation;  
 $\delta$  = Error of estimation.

In words, this equation represents “the actual mean to be within the ( $\pm\delta$ ) interval of the mean estimated through the experiment with a probability of 95 percent, a minimum of ( $N$ ) observations are needed to calculate the estimated mean.” Since the actual population standard deviation was unknown, an accepted method of using one-fourth of the difference in extreme values was applied (16). Error of estimation was fixed at three percent. A basic calculation of sample size was completed as follows:

$$\begin{aligned} \sigma &= (100\% - 0\%) / 4 = 25\%; \\ \delta &= 3\%; \\ N &\geq (1.96 \sigma / \delta)^2 = 266.8 \end{aligned}$$

Thus, a minimum of 267 observations were required for both pedestrians and bicycles to estimate the accuracy of detection and classification with an error of two percent and a confidence interval of 95 percent. Note that all statistically-based sample size calculations provide only a minimum estimate of the number of samples needed. Given the pedestrian and bicycle volume at the proposed study site, at least 350 observations were achievable.

### Site Selection

Because of the unique elements associated with this research, an “ideal” experimental site would require a number of necessary attributes. As a minimum, the site selected for field data collection required the following:

- A facility used by both pedestrians and bicyclists;
- Volume of both pedestrians and bicycles sufficient to record the number of observations needed within a reasonable length of time;
- An AC power source that could be used for the experiment within 500 feet of the site;
- A suitable support available to mount and dismount the active infrared device easily and effectively; and
- A location for computer setup and observation from a safe location. The positioning of observers and computer setup must not present an impediment to the movement of pedestrians and bicyclists using the facility.

Fortunately, a suitable site that met each of the criteria was located near the University of Massachusetts Amherst (UMass) campus. The Norwottuck Rail Trail is a pedestrian and bicycle facility that runs east-west approximately one mile south of the UMass campus. Extending a total of 8.5 miles, the Norwottuck Rail Trail links Northampton, Hadley, Amherst, and Belchertown, Massachusetts along a former Boston & Maine Railroad right-of-way (17, 18). A layout of the trail is presented in Figure 15. The Norwottuck Rail Trail is actively used by both pedestrians and bicyclists. Weekend and nighttime volumes can be relatively high. Additionally, several grade crossings along the trail provided ideal study locations since the Autosense II device could be placed above the trail on the grade crossing structure. A study site was selected at a location where the trail passed through a tunnel under SR 116 in Amherst, MA. This location is marked with an “X” in Figure 15.

Figure 16 shows the data collection location and the field setup of the Autosense II device. The trail’s level terrain in this location provided easy access for pedestrians, people in wheelchairs, joggers, skaters, and bicyclists of all ages and abilities. A local building supply warehouse located along the trail provided an AC electrical power supply location. Fencing on either side of Route 116 over the tunnel provided a solid support structure for attaching the Autosense II device. To assure that all public agencies were aware of our field data collection activities and to gain appropriate approvals to collect field data, a ‘Special Permit’ was obtained from the Amherst Regional Office of Department of Environmental Management (DEM).



Figure 15. Norwottuck Rail Trail.

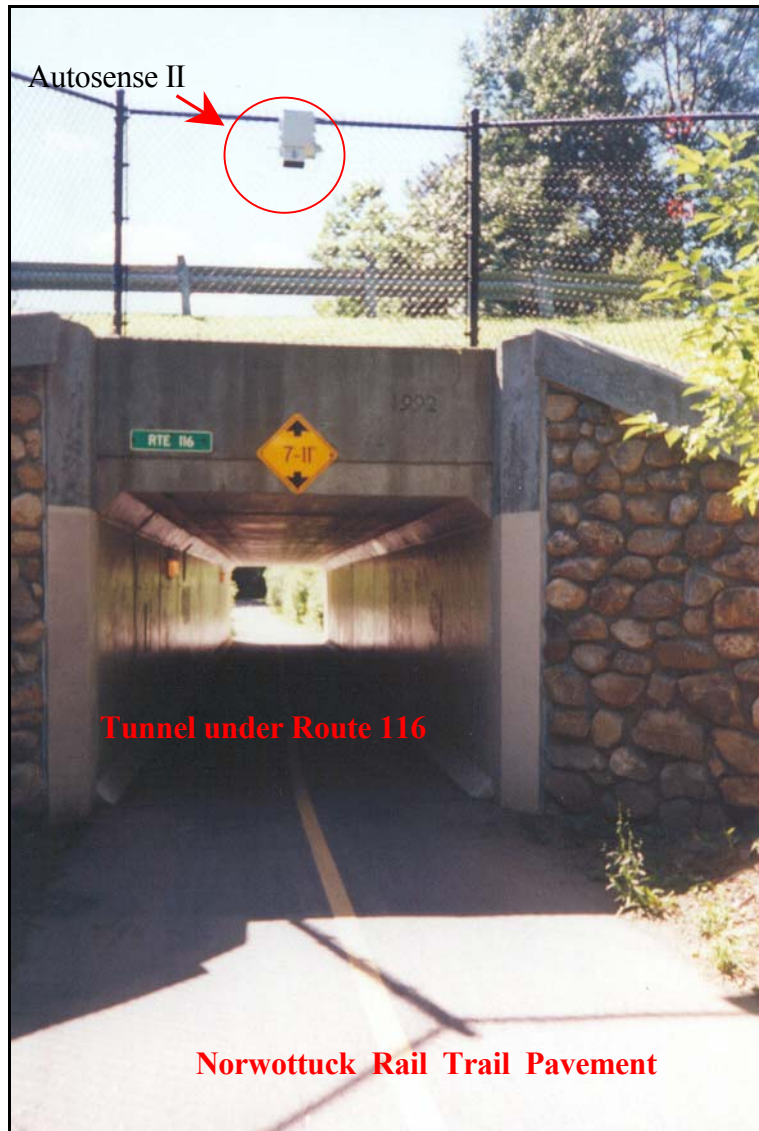

**Figure 16. Norwottuck Rail Trail under Route 116 in Amherst, MA.**

## **Experimental Setup**

The Autosense II device was mounted, using a manufacturer supplied frame, on the overpass fence above the area of observation as shown in Figure 16. Although a mounting height of 23 feet (7 meters) was recommended by the manufacturer, a height of 18 feet (5.5 meters) was selected (measured to the top of the device). A lower mounting height reduced the separation between the beams on the pavement surface to approximately three feet (0.9 meters). Researchers hypothesized that a smaller spacing between beams would increase the likelihood of both pedestrians and bicycles being detected (i.e., simultaneously breaking both beams). The device operated from an AC power source of 90-130 VAC with any frequency from 47 Hz to 440 Hz (an optional configuration will allow operation from 170-240 VAC). Since the device was designed for continuous operation, a power switch was not provided (11). Power for the experiment was drawn from the neighboring warehouse using heavy-duty outdoor power cables.

The device was connected to a suitable desktop computer placed on a portable table near the study site. The necessary software for the operation of the device was installed on the computer. The software contained the ability to make changes in configuration of the device and communication characteristics to match field conditions.

## **Data Collection**

The software package supporting the Autosense II device was capable of saving all output data to a text file, and thus accommodated the review of results after the site experiment was concluded. The software allows to the user to select one of three types of export data:

- *Raw range measurement data* or data obtained before processing by the algorithms. This data consisted of a series of numbers, which are not comprehensible.
- *Full message data* provided all available data including detection messages for each beam and classification messages after processing by the algorithms. Each observation was tagged with the time of the observation.
- *Filtered message data* excludes all erroneous data. The data consist of only the final classification messages; detection data are not presented.

Since the research objective was to test and observe the device in many different modes of operation, the full message data option was chosen. The full message data option provided all detection and classification data regardless of how the “detection” was classified. In contrast, filtered data provides very little pedestrian data as the algorithm filters out most pedestrian detections because of classification problems.

To provide control and evaluate the accuracy of the Autosense II detection and classification, manual pedestrian and bicycle counts were simultaneously collected. A pre-designed data collection form was used, as shown in Appendix A. To explore the range of device capabilities and performance levels, data were collected under different light and temperature conditions.

---

## CHAPTER 5 ANALYSES AND RESULTS

---

The experiment was conducted during the summer and fall of 2001. Data consisted of the manually collected trail user volumes, separated into pedestrian and bicycle volumes, with the simultaneously collected detection and classification data from Autosense II. The data obtained from Autosense II were compared with the manual counts to evaluate the performance of the device in detection and classification. Results of the experiments are summarized in Table 4.

A total of 357 pedestrians and 924 bicyclists were observed during the data collection process. Both numbers exceeded the 267 observations computed in the minimum sample size calculations. The results showed that Autosense II was very effective in both detection and classification of bicyclists. Ninety-seven percent of the bicyclists observed were accurately detected. Classification of bicyclists was less accurate, as only 77 percent of the bicyclists detected were classified (as motorcycles). The remaining 23 percent of bicyclists detected were not classified as motorcycles or any other vehicle type.

Autosense II also performed quite well in pedestrian detection. Ninety-two percent of pedestrians observed were successfully detected. The reasons why eight percent of pedestrians were undetected are not completely clear. As expected, no pedestrians were classified correctly since the algorithms were not designed for this function and pedestrians were unable to simultaneously break both beams spaced at three feet. Nevertheless, most “unknown” classifications were pedestrians and in the most primitive data collection form, and could be assumed to be pedestrians.

### ANALYSIS OF OBSERVATIONS

Apart from the quantitative results of the percentage of correct and incorrect detections and classifications, general observations were made throughout the experiment. These observations were analyzed both to comprehend the operation of the actual algorithms and to identify causes behind the results obtained.

**Table 4. Results of Field Experiments**

<b>Trail User</b>	<b>Number of Observations</b>	<b>Percent of Correct Detections</b>	<b>Percent of Correct Classifications</b>
<b>Bicyclists</b>	924	97	77 <sup>a</sup>
<b>Pedestrians</b>	357	92	N/A

<sup>a</sup> Classified as motorcycle.



## **Bicycle Detection and Classification**

The high success rate in classifying bicycles was attributed to the fact that the shape, height, length, and width characteristics of bicycles and motorcycles are similar. This similarity can be observed from the computer generated color image, referred to as the false color image, produced by bicyclists when they pass under Autosense II as shown in Figure 17. This figure also illustrates that active infrared technology has an accurate imaging capability.

Observations made during bicyclists detection and classification were significant in developing an understanding of the internal algorithms used within Autosense II. To further explain, Figures 18 through 21 demonstrate the process within the algorithms for detection, calculation of characteristics, and classification.

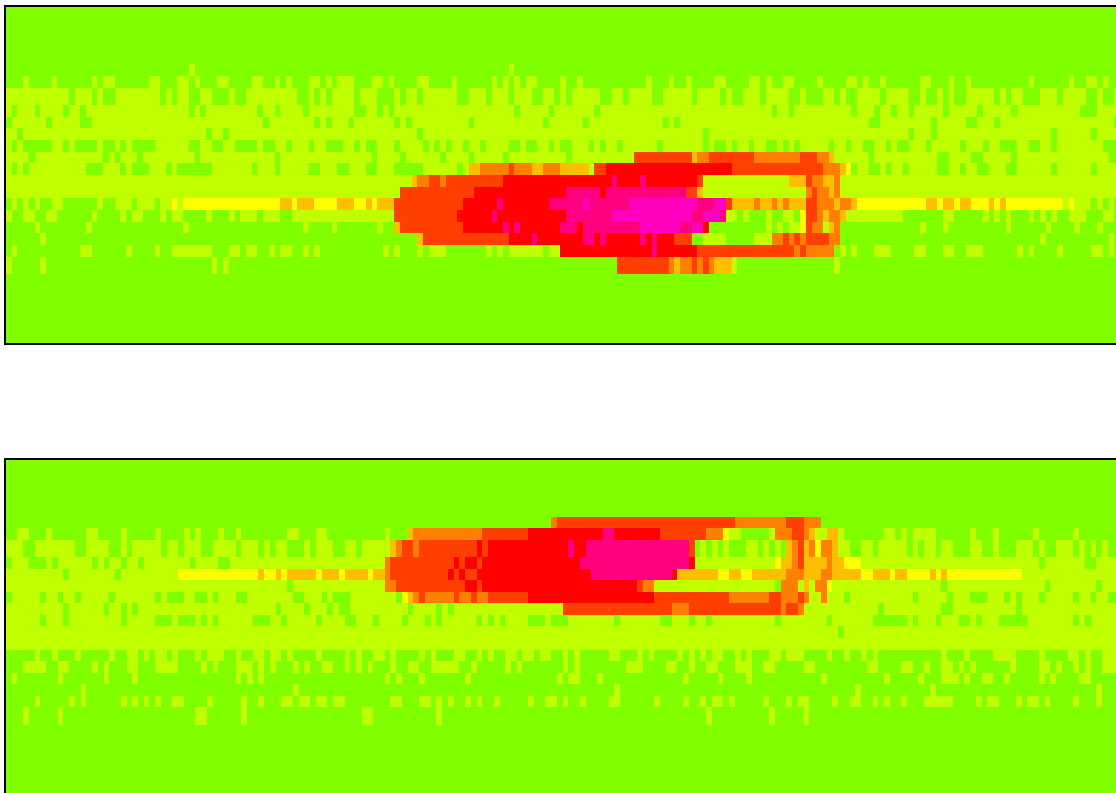

**Figure 17. Sample False Color Image of a Bicyclist.**

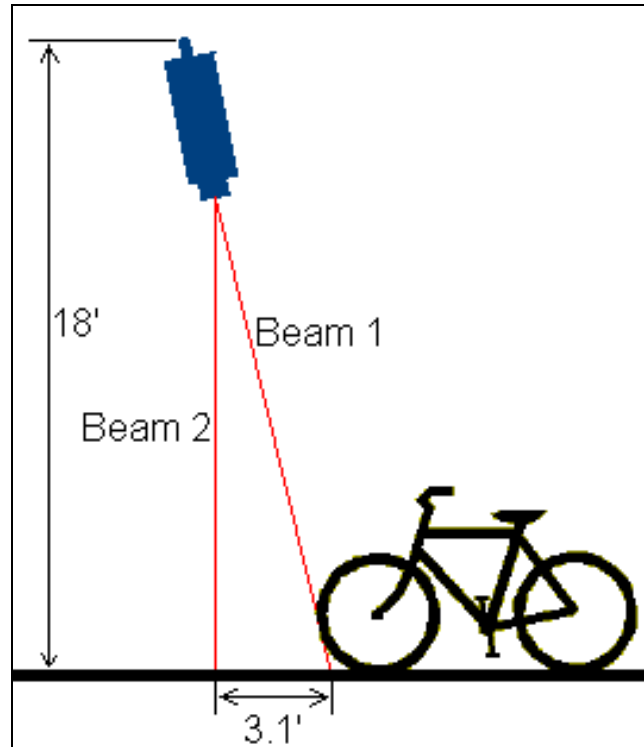

**Figure 18. Bicycle Entering Beam 1.**

As the bicycle enters Beam 1, the time ( $t_1$ ) at which it first cut Beam 1 is noted. This time corresponds to “Message 1: Beam 1 vehicle detection” in the text data file. As the bicycle enters Beam 2, the time ( $t_2$ ) at which the bicycle cuts Beam 2 is noted. This time corresponds to “Message 2: Beam 2 vehicle detection” in the text data file. The difference in detection times ( $t_2 - t_1$ ) is used to calculate the speed ( $s$ ) based on the distance ( $d$ ) between the two beams on the pavement:

$$s = d/(t_2 - t_1)$$

At this instant, the bicycle is simultaneously cutting both beams and will continue to do so until it leaves Beam 1.

The time ( $T_1$ ) at which the bicycle leaves beam 1 is noted. This time corresponds to “Message 3: Beam 1 end of vehicle” in the text data file. The length of the vehicle is calculated:

$$L = (T_1 - t_1) \times s$$

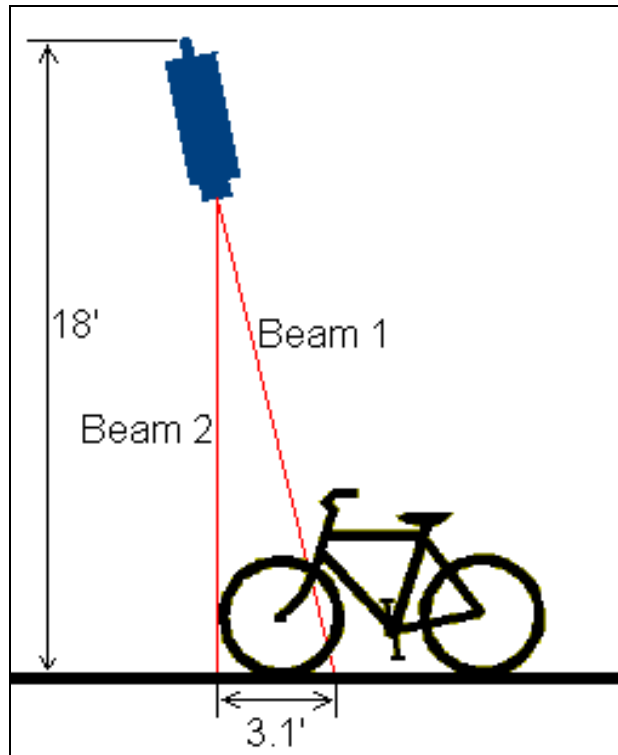

Figure 19. Bicycle enters Beam 2.

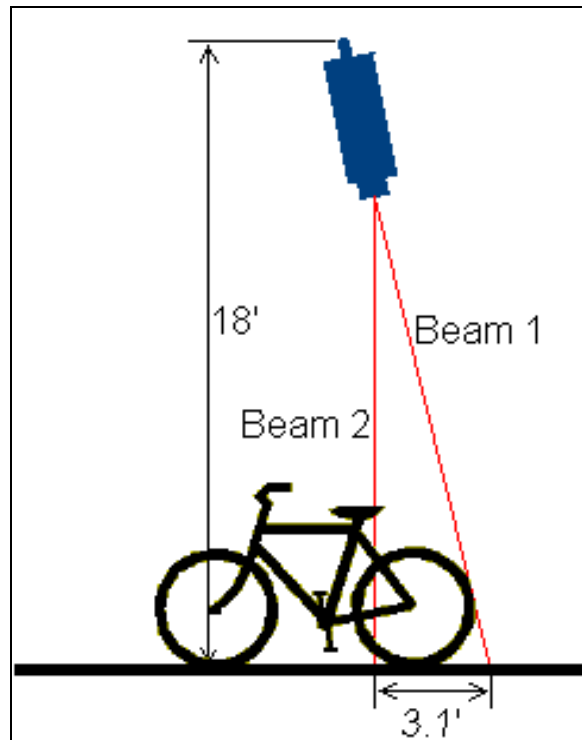
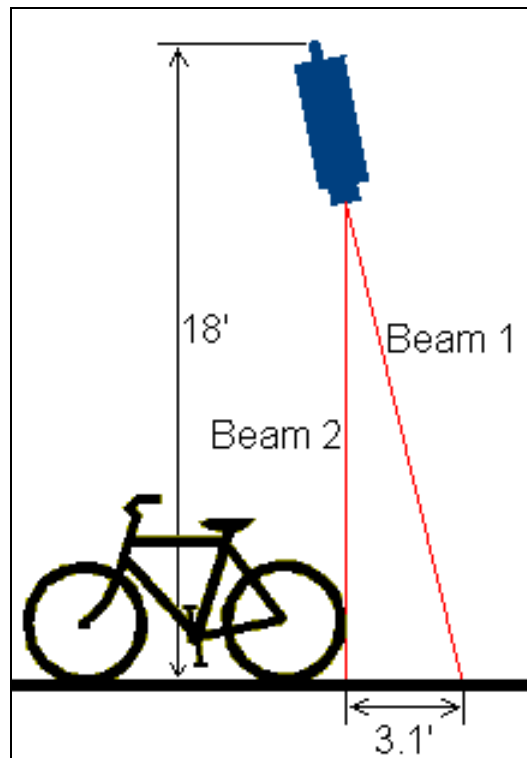

Figure 20. Bicycle leaves Beam 1.



**Figure 21. Bicycle leaves Beam 2.**

The time ( $T_2$ ) at which the bicycle leaves beam 2 is noted. This time corresponds to “Message 4: Beam 2 end of vehicle” in the text data file. Length of the vehicle could also be calculated based on times from Beam 2:

$$(T_2 - t_2) \times s$$

Width is calculated based on the left most and right most angle positions of infrared rays cut by the object in both beams. The range measurements of the beams are used for building a profile of the vehicle and for height calculation. These range measurements also help to produce a false color image. “Message 5” (vehicle classification) always follows “Message 4” (Beam 2 end of vehicle), as “Message 4” signals to the algorithm that the object has completely passed through the beams. However, it was unclear whether the final classification is executed based on an image comparing process or by just comparing the length, height, and width characteristics to the standard dimensions. A sample of a text data file is included in Appendix B.

At the reduced mounting height of 18 feet (5.5 meters), the distance between the beams on road surface was reduced to approximately three feet (0.9 meters) as opposed to four feet (1.2 meters) at the recommended mounting height of 23 feet (7 meters). As explained, the algorithm uses the distance between the two beams in calculating the length of the object. Note that this revised distance must be calibrated to the mounting height within the software or the algorithm will overestimate the length of the objects passing under it. Therefore, the reduction in the mounting height of the device may have had a negative impact on bicyclist classification. Nevertheless, at a greater height the device

would filter out a greater percentage of pedestrians from the final data. Thus, this decision represented a trade-off in order to obtain a reasonable understanding of pedestrian detection and classification.

It was observed that even in instances of correct detection and classification, the length was calculated to be zero for bicyclists in the opposing direction, i.e., those that cut Beam 2 first. No length measurement produced was due to the algorithm expecting Beam 1 to be cut before Beam 2. No calculating procedure was programmed for the reverse direction. The pseudo images were not affected by the direction of movement of the trail users. No consistent relation was observed between the direction of movement and accuracy of classification.

### **Pedestrian Detection and Classification**

The false color image produced by a pedestrian passing under Autosense II is shown in Figure 22. Almost all the errors in pedestrian detection observed were attributed to multiple detections for a single user caused by movement of arms and legs.

Consider the movement of a bicyclist. The passage of a bicyclist under the Autosense II device does not involve significant relative movement between parts of the bicycle (and bicyclist). As a result, bicyclists provide a very static object mass for detection and classification. However, in the case of pedestrians, there is significant relative movement between the main body and extremities through arm swing and walking stride. This phenomenon is illustrated in Figures 23 through 26. Some pedestrians did not cut both beams at the same time as shown in Figure 24 and hence were filtered out of the final data. If the arm and leg movements produce more than one message, “Message 4: Beam 2 end of vehicle,” the algorithm attempted to classify and count after every such message. Hence, in the final message data, it appears as if the device has detected multiple trail users. Such instances were classified as incorrect detections.

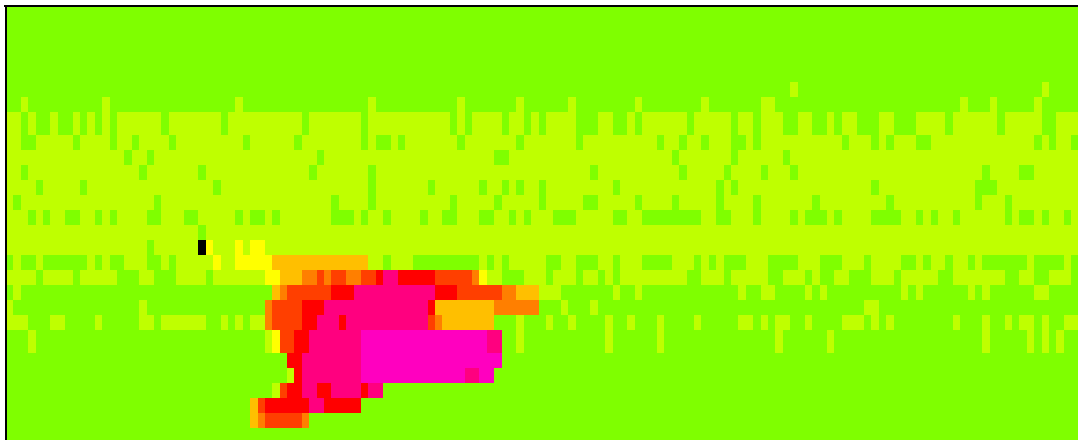

**Figure 22. False Color Image of a Pedestrian.**

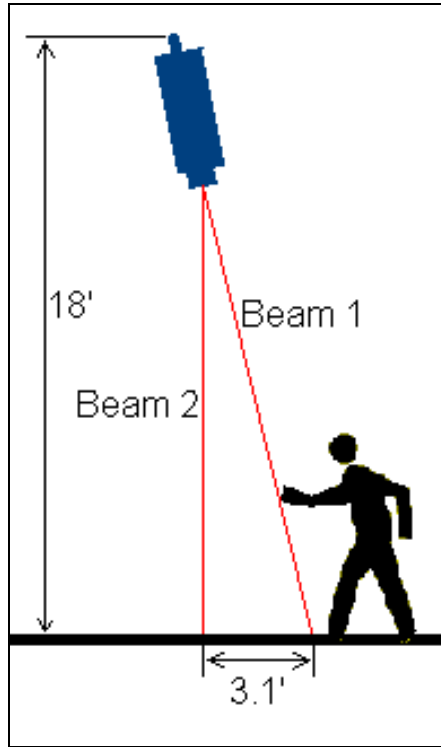

**Figure 23. Pedestrian's Hand Cuts Beam 1.**

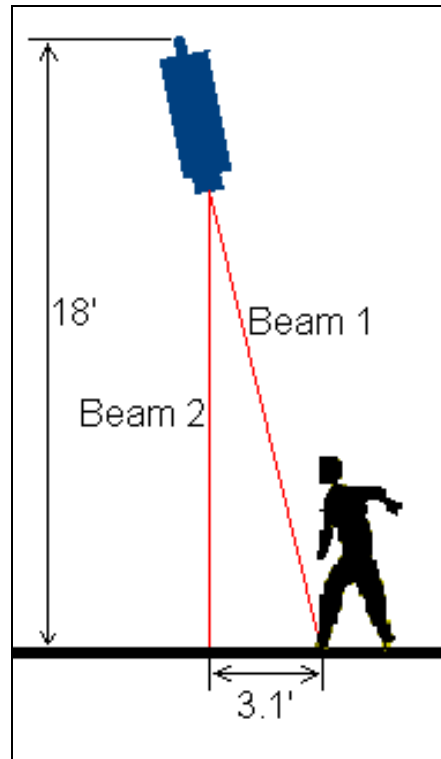

**Figure 24. Hand Swings Back, and a Leg Cuts Beam 1 Resulting in Multiple Detections.**

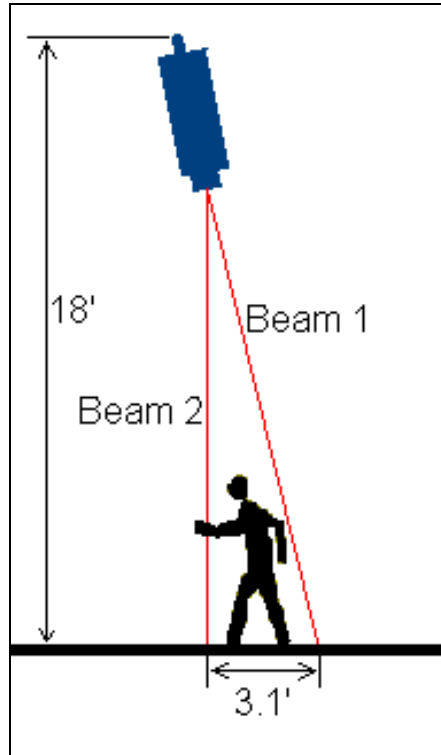

**Figure 25. Pedestrian Moves out of Beam 1 and Cuts Beam 2.**

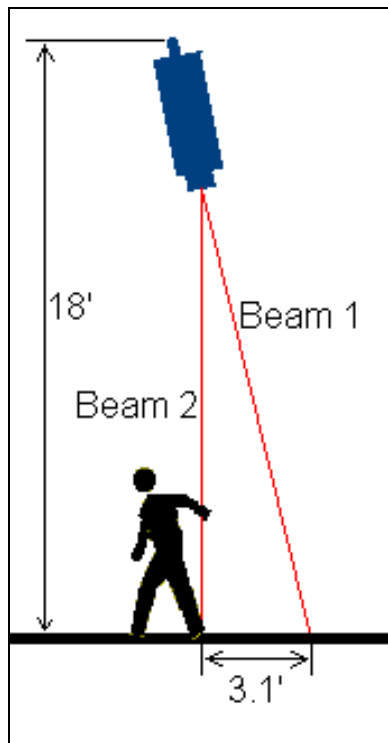

**Figure 26. Multiple Detections are Produced as Pedestrian Exits Beam 2.**

## **Effect of Environmental Factors**

Efforts were made to test the Autosense II device under different types of light and temperature. Light conditions ranged from dusk to bright sunlight and temperature conditions ranged from 35 to 80 degrees Fahrenheit. Light and temperature conditions did not affect the performance of the device. This result is attributed to the fact that active infrared devices do not depend on the ambient radiation to detect objects. Heavy precipitation may affect its performance as it may result in obstruction and scattering of the infrared beams. Because of the open electrical wiring and computer use in the experimental setup, the effects of heavy precipitation were not field tested. Owing to the filtering process of the algorithm, any detection triggered by precipitation would be filtered out.



---

## CHAPTER 6

# CONCLUSIONS AND RECOMMENDATIONS

---

Accommodating pedestrians and bicyclists in planning, design, and construction of transportation facilities requires accurate data. The results of this research study show that none of the ITS technologies reviewed are completely effective in this mission. Active infrared and video image processing are technologies with promising capabilities of pedestrian and bicyclist detection and classification. This research focused on the active infrared technology, specifically the Autosense II.

### ACTIVE INFRARED

Experimental evaluation of the Autosense II active infrared device has shown that it has the capability to accurately detect and classify bicycles, although bicycles are incorrectly labeled as motorcycles. However, in its current configuration and with the accompanying algorithms, the device is not accurate in detecting and classifying pedestrians. The basic installation and configuration of the active infrared device will require changes to accurately detect and classify pedestrians. Changes must be made both on the hardware and software aspects of the device for enhancing its accuracy and capability.

#### Recommendations for Changes in Hardware

The mounting height of the equipment may be reduced from the recommended 23 feet (7 meters) to approximately 12 feet (3.6 meters) so that a pedestrian passing underneath the sensor can simultaneously cut both active infrared beams. Alternatively, the angle between the two beams may be reduced to decrease the beam separation.

The device now operates at the high scan rate of 720 scans per second, as it was designed to work with fast moving vehicles. For pedestrians and bicycles, the scan rate may be reduced without compromising accuracy. With the lower scan rate, the computer would have less computations to complete with each observation. A reduction in computation time will allow the system to process more data in a shorter time.

At the current settings, the device takes 30 range measurements across the width of the pavement. Vehicles have simpler profiles and are much wider when compared to pedestrians or bicycles. Hence, while 30 range measurements generally produce an accurate profile for vehicles, they may not be sufficient for pedestrians and bicycles. Increasing the number of range measurements to 45 may enhance the accuracy of classification.

#### Recommendations for Changes in Software

Algorithms used for the classification of motorcycles can be used, with minor changes, to fit bicycle dimensions more closely. A new algorithm is required for pedestrian detection and classification. All changes to the algorithms should take into account any modifications to the device's configuration.

Additionally, the algorithms currently used are not capable of calculating the length of an object passing under it, if the second beam is cut before the first beam. Changes should be made to the

algorithms to enable length calculation in both directions. This change in directional capabilities may improve the accuracy of classification. It can be observed from Figures 27 and 28 that the false color images produced by pedestrians and bicyclists are clearly distinguishable. These images exhibit that length is the major difference between pedestrians and bicyclists. Therefore, if accurate calculation of length can be ensured, it can be used as the primary criterion for distinguishing between pedestrians and bicyclists. Even if the device is only capable of classifying bicyclists accurately, length logic can be used for accurate data collection on pedestrian and bicycle facilities by simply classifying all other detections as pedestrians.

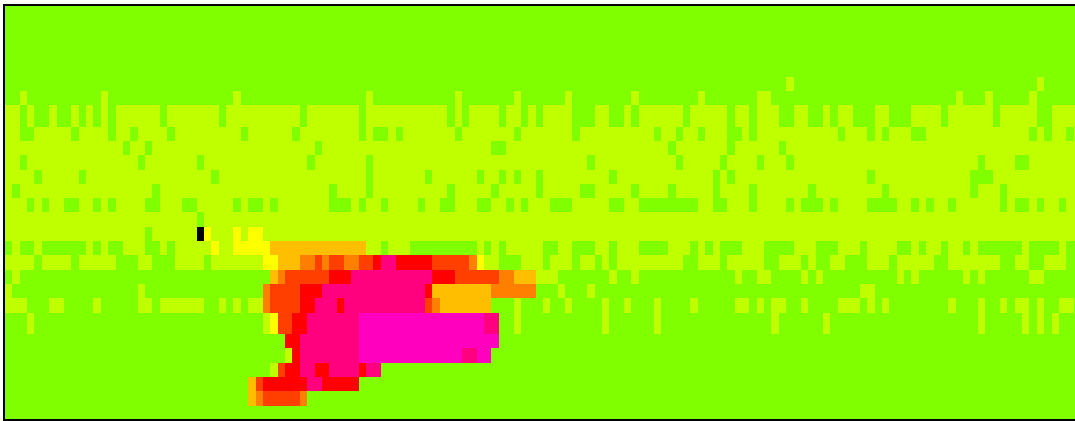

**Figure 27. False Color Image of a Pedestrian.**

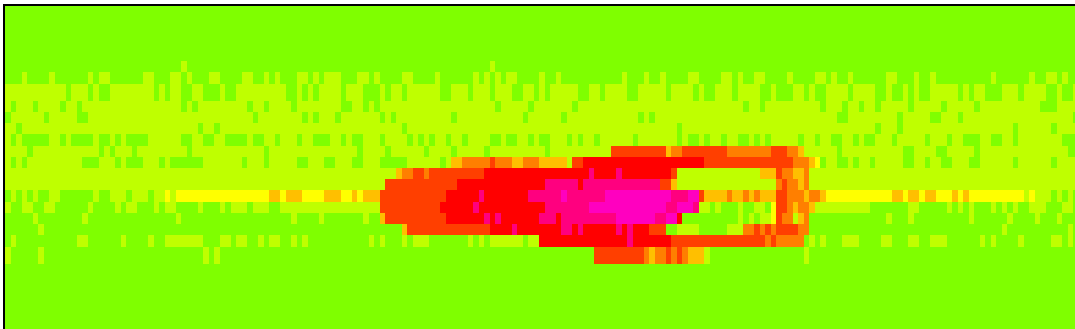

**Figure 28. False Color Image of a Bicyclist.**

### **Recommendations Regarding Data**

A question that is asked when developing a new application such as this is: “How accurate should the data collected be?” While data with 100 percent accuracy would be ideal for any kind of application, more often than not such accuracy is very difficult to attain. The accuracy of the data needed varies depending on the usage or application of the data, and in most cases, less than fully

accurate data are sufficient. In transportation engineering applications, 85 percent accuracy is often acceptable as it represents an 85<sup>th</sup> percentile and a one-tailed statistical relationship of one standard deviation above the mean. Considering the fact that Autosense II had not been originally designed to detect or classify pedestrians and bicycles, achieving 85 to 90 percent accuracy in pedestrian and bicycle data collection appears to be achievable.

As noted in the previous section, Autosense II produces data in three forms. The original raw message data is incomprehensible. The intermediate form of data that was used for this research contains messages for each detection and classification. While this was ideal for research purposes to understand the operation of the device, it cannot be effectively used for data collection purposes. The final message data format is in fact the most suitable form for data collection, though in the current state, most pedestrian detections would be excluded from this data. None of the data formats produce final counts for each classification category. It is recommended that this feature be included in the software.

### **Other Findings**

Several final points can be made regarding the active infrared device. First, when a pedestrian and bicycle simultaneously passed under the device, they were often classified incorrectly. Though this does pose a difficult case of classification, it is believed that such instances can be classified correctly using the false color image data produced. There are a variety of trail users, each with unique characteristics. It may not be possible to identify each of these user types, but detection and general classification appear possible.

The active infrared device was not labor intensive and it could be installed or removed in 30 minutes or less. Two people were required for installing the device along with an appropriate mounting source (pole, grade crossing) and power supply. The active infrared device was not affected by general light, temperature, and weather conditions. Reliability appeared to be excellent.

### **Recommendations for Future Research**

It is recommended that additional research be conducted to better understand the underlying algorithms used in active infrared applications and to make the changes recommended above. We believe this technology can be successfully modified to obtain accurate detection and classification of pedestrians and bicycles and assist in reliable and widespread data collection.

---

## REFERENCES

---

1. Bureau of Transportation Statistics, *Bicycle and Pedestrian Data: Sources, Needs & Gaps*, June 1998.
2. FHWA, *The National Bicycling and Walking Study: Transportation Choices for a Changing America*, 1994.
3. Massachusetts Highway Department, *Statewide Bicycle Transportation Plan*, 1998.
4. TEA-21 - *Moving Americans into the 21<sup>st</sup> Century*, <http://www.fhwa.dot.gov/tea21/>. Accessed on: May 21, 2000.
5. Massachusetts Highway Department, *Massachusetts Pedestrian Transportation Plan*, 1998.
6. FHWA, *Bicycle/Pedestrian Trip Generation Workshop: Summary*, March 1998.
7. FHWA, *Development of IVHS Traffic Parameter Specifications – Task - A Report for Detection Technology for IVHS*, June 1994.
8. Klein, Lawrence A., *Sensor Technologies and Data Requirements for ITS*, Artech House Publishing, 2001.
9. *ITS Decision*, <http://www.path.berkeley.edu/~leap/>, Accessed on: Feb.10, 2000.
10. Traffic 2000 Products and Services, <http://www.traffic-2000.co.uk/>. Accessed on: Jan. 15, 2000.
11. Schwartz Electro-Optics, Inc., *Autosense II Vehicle Detection & Classification Sensor – User’s Manual & System Specification*, April 1998.
12. Schwartz Electro Optics, Inc., Autosense Products, <http://www.seord.com/Commercial%20Sensors%20Division/autosense.htm>. Accessed on: Jan.14, 2000.
13. Nestor Traffic Systems, <http://www.nestor.com/Nstraffic/>. Accessed on: Aug.11, 2000.
14. Microwave sensors, <http://www.microwavesensors.com/>. Accessed on: Jan 15, 2000.
15. ASIM Technologies, <http://www.asim.ch/>. Accessed on: Jan 28, 2000.
16. Mendenhall, William, Robert J. Beaver and Barbara M. Beaver, *Introduction to Probability and Statistics*, 10<sup>th</sup> Edition, Duxbury Press, 1999.
17. Department of Environmental Management – Norwottuck Rail Trail, <http://www.state.ma.us/dem/parks/nwrt.htm>, Accessed on: May 21, 2000.
18. Massachusetts Office of Travel & Tourism, Outdoor Adventures – Biking – Norwottuck Rail Trail, [http://www.mass-vacation.com/outdoor/bike\\_norwottuck.html](http://www.mass-vacation.com/outdoor/bike_norwottuck.html). Accessed on: May 21, 2000.

**APPENDIX A**  
**Detection and Classification Data Sheet Example**



**Pedestrian and Bicycle Detection and Classification Data Sheet**



**Location: Norwottuck Rail Trail Underpass at Route 116**

**Collected By: RD**

**Date: 5/12/2002**

**Time: 1:05 PM**

**Weather: Sunny, Temp. 75 to 85° F**

Observation Number	Visual		Autosense Response		
	Emerging from Tunnel	Going into Tunnel	Detection	Classification	Other
1	Ped		Multiple	Multiple	
2	Bike		Single	Motorcycle	
3	Bike		Single	Motorcycle	
4	Bike		Single	None	
5	Bike		Single	Motorcycle	
6	Bike		Single	Motorcycle	
7		Roller Blade	Single	None	
8		Bike	Single	Motorcycle	
9	Bike		Single	Motorcycle	
10	Bike		Single	None	
11	Bike		Single	Motorcycle	
12		Bike	Single	Motorcycle	
13	Bike		Single	Motorcycle	
14		Bike	Single	Motorcycle	
15	Roller Blade		Multiple	None	
16		Bike	Single	Motorcycle	
17	Bike		Single	Motorcycle	
18		Bike	Single	Motorcycle	
19	Bike		Single	Motorcycle	
20	Bike		Single	None	
21	Bike		Single	Motorcycle	
22	Bike		Single	Motorcycle	
23	Bike		Single	Motorcycle	
24	Ped		Multiple	Multiple	
25	Bike		Single	Motorcycle	
26	Bike		Single	Motorcycle	
27		Bike	Single	Motorcycle	
28	Roller Blade		Multiple	None	
29	Roller Blade		Single	None	
30	Bike		Single	Motorcycle	
31	Bike		Single	None	

**APPENDIX B**  
**Text Data File Example**

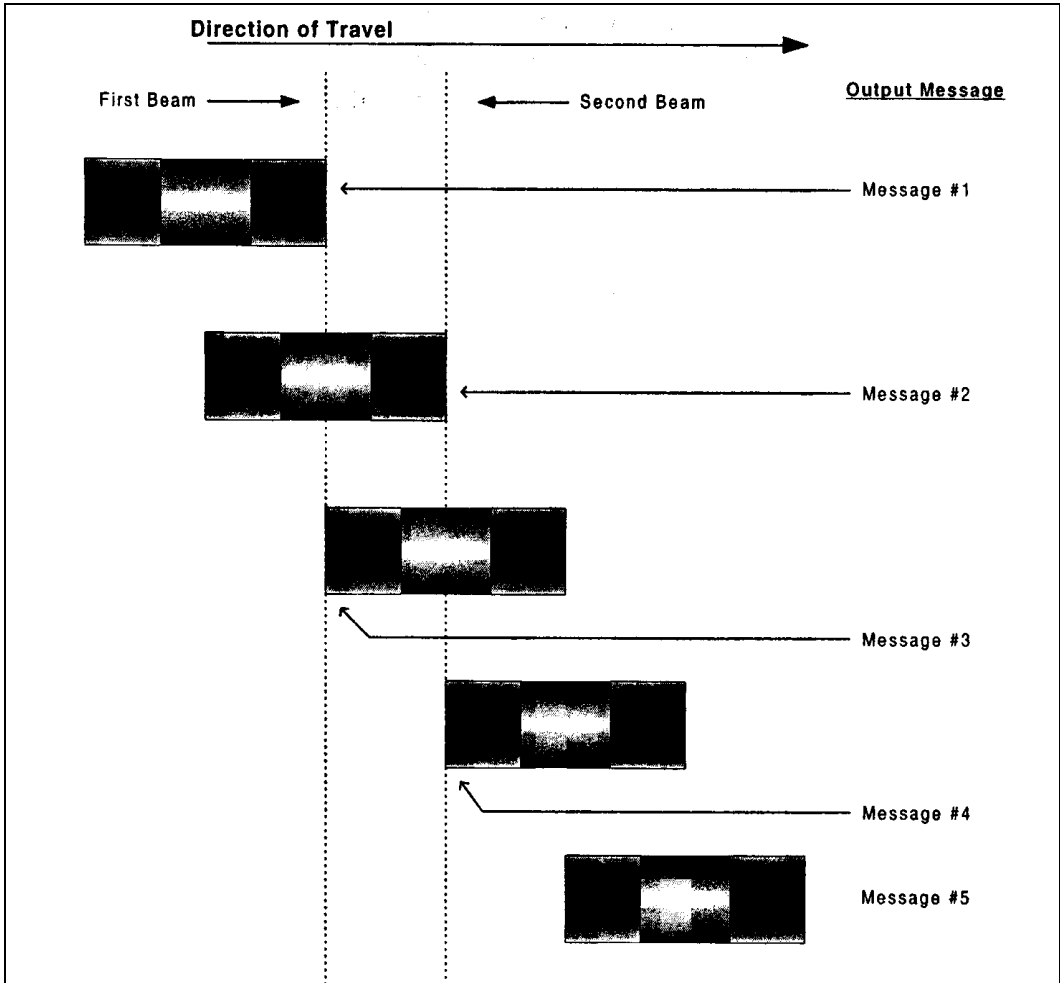

Message Positions



1<sup>st</sup> BEAM VEHICLE DETECTION ID = 49

2<sup>nd</sup> BEAM VEHICLE DETECTION ID = 49

Left Edge Pos: 23

Rght Edge Pos: 29

Speed (mph).. : 6

1<sup>st</sup> BEAM END OF VEHICLE ID = 49

Left Edge Pos: 20

Rght Edge Pos: 29

1<sup>st</sup> BEAM VEHICLE DETECTION ID = 50

1<sup>st</sup> BEAM END OF VEHICLE ID = 50

Left Edge Pos: 21

Rght Edge Pos: 28

2<sup>nd</sup> BEAM END OF VEHICLE ID = 49

CLASSIFICATION MESSAGE ID = 49

Passenger Car w/ Trailer .....: 70%

Height: 5.25 ft

Length: 18.25 ft

Width: 9

Speed: 6

(Where width is in degrees and speed is in mph).

### Output File

CLASSIFICATION MESSAGE      ID = 49

Passenger Car w/ Trailer .....: 70%

Height: 5.25 ft

Length: 18.25 ft

Width: 9

Speed: 6

Left Edge Pos: 20

Right Edge Pos: 29

**Filtered Output**